

# Sartorius Basic<sup>plus</sup>

Electronic Semi-micro-, Analytical  
and Precision Balances

Installation and Operating Instructions

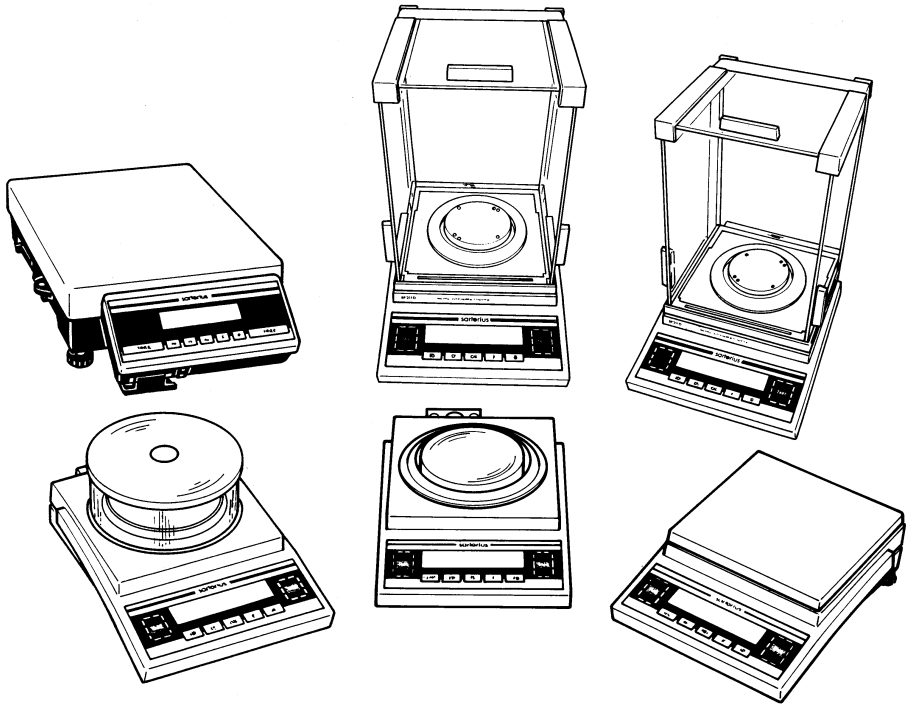



# Contents

	Page		Page
General Views of the Balances	5	Troubleshooting Guide	26
Warranty	12	Care and Maintenance	27
Storage and Shipping Conditions	12	Balance Operating Menu	28
Installation Instructions	13	Changing Menu Code Settings	28
Ambient Conditions	13	Accessing the Menu	29
Getting Started	15	Undoing All Menu Code Changes – Reset Function	30
Preparing the Weighing Chamber/Balance	15	Balance Operating Parameters	31
Connecting the Balance to AC Power	16	Adapting the Balance to Ambient Conditions	31
Voltage Selection	17	Standard Weighing and Filling Modes	31
Safety Precautions	17	Stability Range	31
Information on Radio Frequency Interference	17	Tare Parameter	32
Connecting Electronic Peripheral Devices	18	Auto Zero Function	32
Information on Weighing Electrostatically Charged Samples	18	Adjustment, Calibration and Linearization Functions Using CAL	32
Leveling the Balance Using the Level Indicator	19	Weighing Using Two Weighing Units	33
Operating the Balance	20	Weight Units	33
Warmup Time	20	Display Modes	34
Turning the Display On and Off	20	Interface Parameter Settings	35
Self-Test	20	Utilities for Printouts or Data Transfer	36
Taring	21	Data Output Parameter	36
Simple Weighing	21	Auto Print	36
Calibration/Adjustment	22	Data Output at Defined Intervals	36
Internal Calibration	22	Data ID Codes	37
External Calibration	23	Additional Functions	38
Calibration Test	24	Menu Access Function	38
Blocking the Calibration/Adjustment Functions	24	Blocking the Keys	38
Interface Port	24	Universal Switch for Remote Control	39
Below-Balance Weighing	25	Power-On Mode	39
Fastening an Antitheft Locking Device	25		

	<u>Page</u>		<u>Page</u>
Application Programs	40	ISO/GLP-compliant Printout	
Tare Memory	40	or Record	50
Practical Example:		Printout/Record for	
Tare – Net – Gross Weights	40	Adjustment or Calibration and	
Practical Example: Net Total	41	Linearization Functions	51
Weighing in Percent	42	Data Printout/Record	
Practical Example: Determination		(ISO/GLP-compliant)	52
of the Residual Weight in Percent	44	Data Printout/Record for	
Counting	45	Application Programs	53
Practical Example:		Interface Description	54
Counting Small Parts	46	Pin Assignment Chart	66
Animal Weighing/Averaging	47	Cabling Diagram	67
Animal Weighing in the		Specifications	68
Automatic Start Mode	49	Standard Features	68
		EC Pattern Approval	76
		Accessories (Options)	84
		Declaration of Conformity	87

# BP 211 D, BP 211 D-OCE

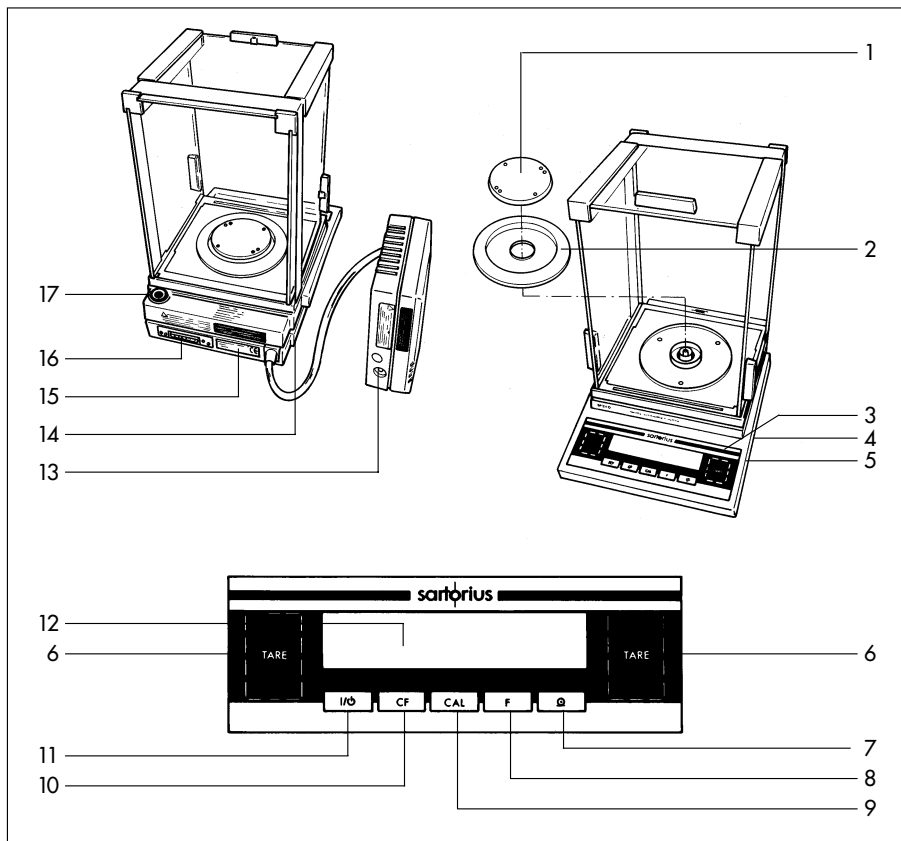

No.	Designation	Order no. for replacement	No.	Designation	Order no. for replacement
1	Weighing pan	69 B20116	12	Weight display	
2	Shield disk	69 B20117	13	DC jack	
3	Metrological ID label for verified balances approved for use as legal measuring instruments		14	Verification ID label with metrological data for verified balances approved for use as legal measuring instruments	
4	Menu access switch		15	Manufacturer's label with the <b>CE</b> mark of conformity	
5	Leveling foot	69 B20005	16	Data interface port	
6	Zero-setting and tare keys <b>TARE</b>		17	Level indicator	
7	Print key (data output) <b>Q</b>		Not shown:	Dust cover	69 60BP07
8	Function key <b>F</b>			Caps and plugs (set)	69 B20009
9	Adjustment/calibration key <b>CAL</b>				
10	CF key (clear function) <b>CF</b>				
11	On/off key <b>I/O</b> (standby)				

BP 301 S, BP 221 S, BP 161 P, BP 121 S, BP 61 S, BP 301 S-OCE,  
BP 221 S-OCE, BP 161 P-OCE, BP 121 S-OCE, BP 61 S-OCE

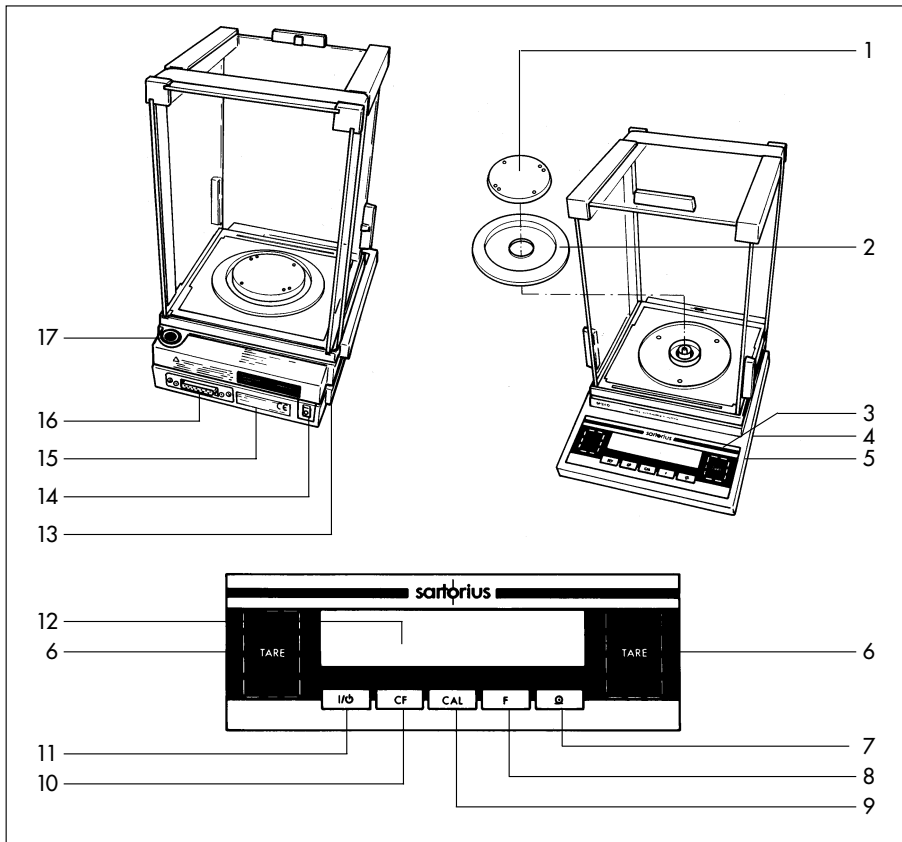

No.	Designation	Order no. for replacement	No.	Designation	Order no. for replacement
1	Weighing pan	69 B20116	12	Weight display	
2	Shield ring	69 B20117	13	Verification ID label with metrological data for verified balances approved for use as legal measuring instruments	
3	Metrological ID label for verified balances approved for use as legal measuring instruments		14	DC jack	
4	Menu access switch		15	Manufacturer's label with the <b>CE</b> mark of conformity	
5	Leveling foot	69 B20005	16	Data interface port	
6	Zero-setting and tare keys <b>TARE</b>		17	Level indicator	
7	Print key (data output) <b>Ⓚ</b>		Not shown:	Dust cover	69 60BP07
8	Function key <b>F</b>			Caps and plugs (set)	69 B20009
9	Adjustment/calibration key <b>CAL</b>				
10	CF key (clear function) <b>CF</b>				
11	On/off key <b>I/O</b> (standby)				

BP 410 S, BP 310 S, BP 310 P, BP 150,  
BP 410 S-OCE, BP 310 S-OCE, BP 310 P-OCE, BP 150-OCE, BP 110-OCE

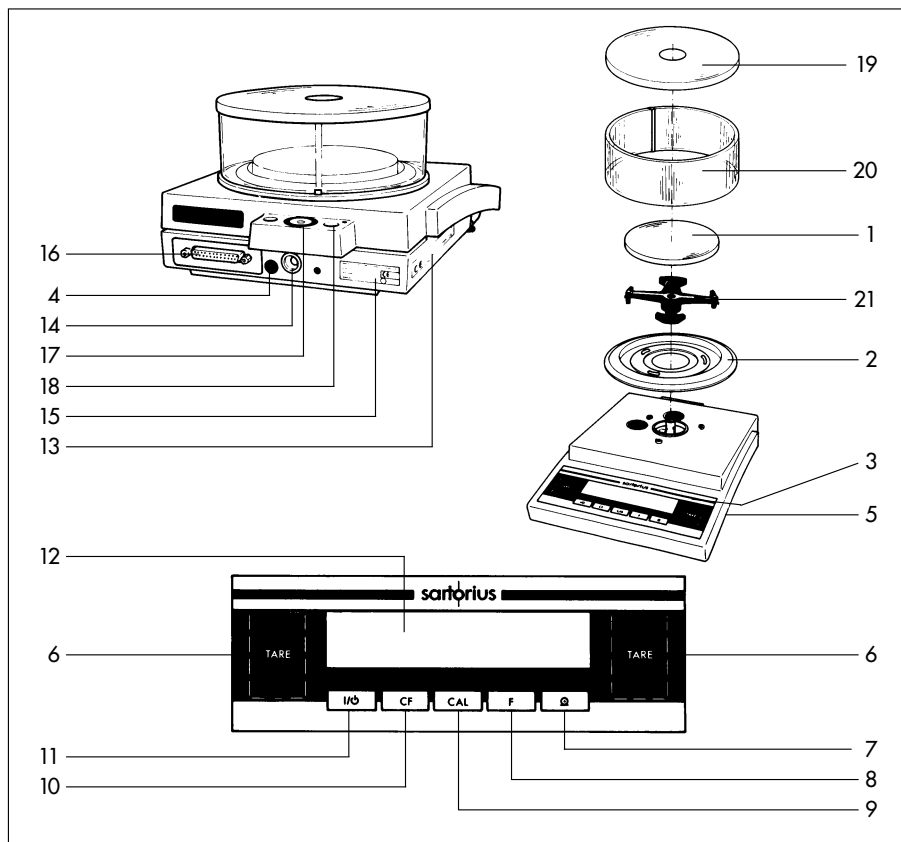

No.	Designation	Order no. for replacement	No.	Designation	Order no. for replacement
1	Weighing pan	69 B20002	13	Verification ID label with metrological data for verified balances approved for use as legal measuring instruments	
2	Shield ring	69 B20015	14	DC jack	
3	Metrological ID label for verified balances approved for use as legal measuring instruments		15	Manufacturer's label with the <b>CE</b> mark of conformity	
4	Menu access switch		16	Data interface port	
5	Leveling foot	69 B20005	17	Level indicator	
6	Zero-setting and tare keys <b>TARE</b>		18	Lug for attaching an anti-theft locking device	69 L22009
7	Print key (data output) <b>Q</b>		19	Draft shield cover	69 L22009
8	Function key <b>F</b>		20	Glass draft shield cylinder	69 L22007
9	Adjustment/calibration key <b>CAL</b>		21	Pan support	69 B20011
10	CF key (clear function) <b>CF</b>		Not shown: Caps and plugs (set)		69 B20009
11	On/off key <b>I/O</b> (standby)				
12	Weight display				

# BP 610, BP 410, BP 610-OCE

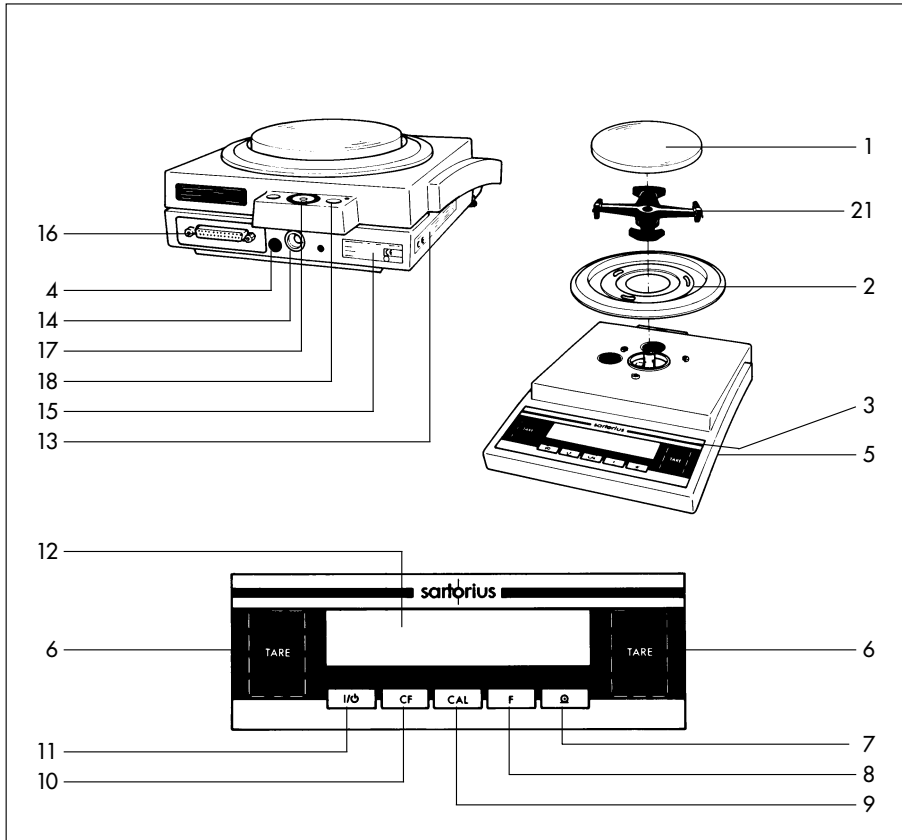

No.	Designation	Order no. for replacement	No.	Designation	Order no. for replacement
1	Weighing pan	69 B20002	13	Verification ID label with metrological data for verified balances approved for use as legal measuring instruments	
2	Shield ring	69 B20015	14	DC jack	
3	Metrological ID label for verified balances approved for use as legal measuring instruments		15	Manufacturer's label with the <b>CE</b> mark of conformity	
4	Menu access switch		16	Data interface port	
5	Leveling foot	69 B20005	17	Level indicator	
6	Zero-setting and tare keys <b>TARE</b>		18	Lug for attaching an antitheft locking device	
7	Print key (data output) <b>Ⓚ</b>		21	Pan support	69 B20011
8	Function key <b>F</b>			Not shown: Caps and plugs (set)	69 B20009
9	Adjustment/calibration key <b>CAL</b>				
10	CF key (clear function) <b>CF</b>				
11	On/off key <b>I/O</b> (standby)				
12	Weighing display				



BP 4100 S, BP 3100 S, BP 3100 P, BP 2100 S, BP 1200, BP 3100 S-OCE,  
BP 4100 S-OCE, BP 3100 P-OCE, BP 2100 S-OCE, BP 2100-OCE, BP 1200-OCE

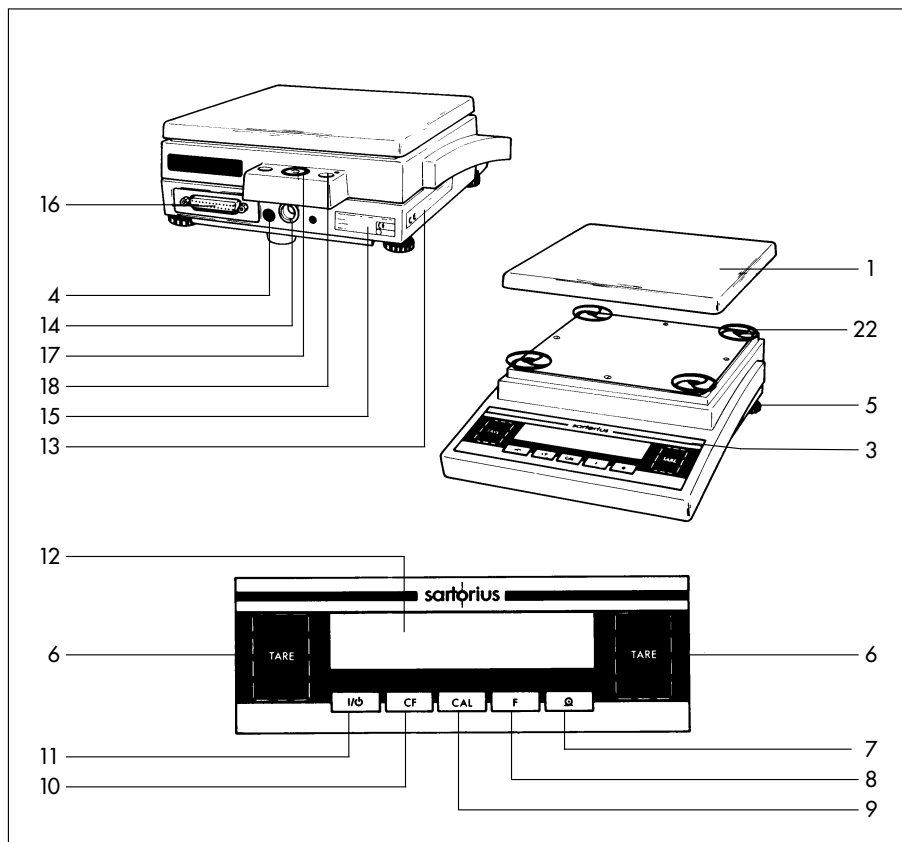

No.	Designation	Order no. for replacement	No.	Designation	Order no. for replacement
1	Weighing pan	69 B20003	13	Verification ID label with metrological data for verified balances approved for use as legal measuring instruments	
3	Metrological ID label for verified balances approved for use as legal measuring instruments		14	DC jack	
4	Menu access switch		15	Manufacturer's label with the <b>CE</b> mark of conformity	
5	Leveling foot	69 B20005	16	Data interface port	
6	Zero-setting and tare keys <b>TARE</b>		17	Level indicator	
7	Print key (data output) <b>Q</b>		18	Lug for attaching an antitheft locking device	
8	Function key <b>F</b>		22	Shock absorber	69 B20006
9	Adjustment/calibration key <b>CAL</b>		Not shown: Caps and plugs (set)		69 B20009
10	CF key (clear function) <b>CF</b>				
11	On/off key <b>I/O</b> (standby)				
12	Weight display				

BP 8100, BP 6100, BP 4100, BP 2100, BP 8,  
BP 8100-OCE, BP 6100-OCE, BP 8-OCE

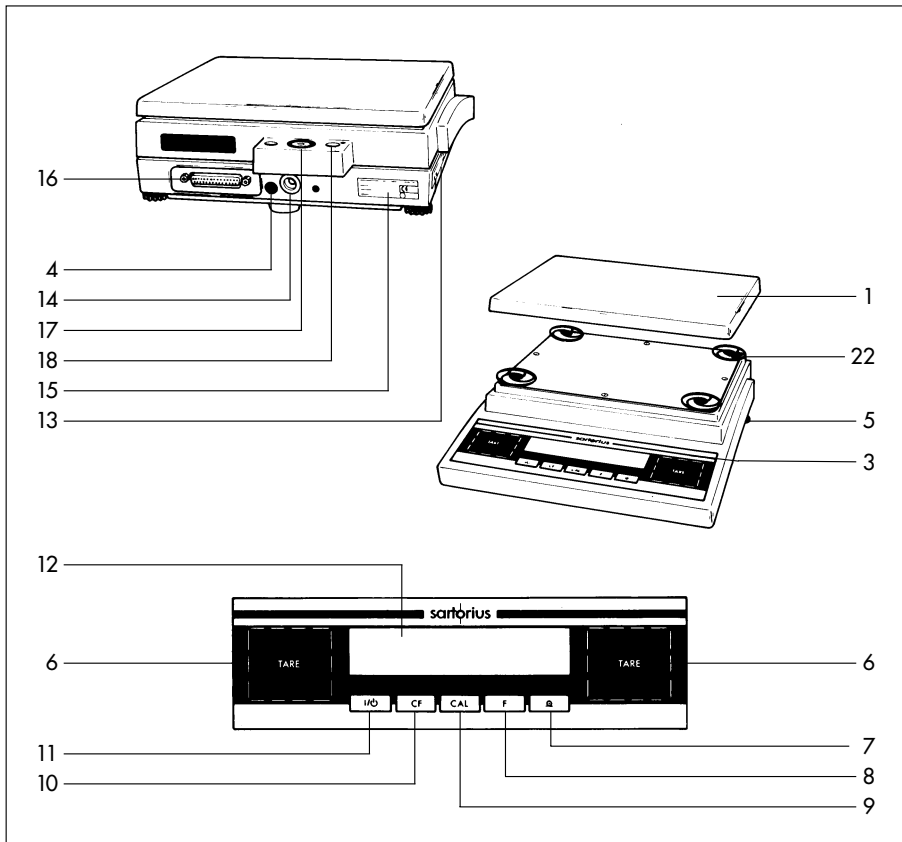

No.	Designation	Order no. for replacement	No.	Designation	Order no. for replacement
1	Weighing pan	69 B20004	13	Verification ID label with metrological data for verified balances approved for use as legal measuring instruments	
3	Metrological ID label for verified balances approved for use as legal measuring instruments		14	DC jack	
4	Menu access switch		15	Manufacturer's label with the <b>CE</b> mark of conformity	
5	leveling foot	69 B20005	16	Data interface port	
6	Zero-setting and tare keys <b>TARE</b>		17	Level indicator	
7	Print key (data output) <b>Ⓚ</b>		18	Lug for attaching an antitheft locking device	
8	Function key <b>F</b>		22	Shock absorber	69 B20006
9	Adjustment/calibration key <b>CAL</b>			Not shown: Caps and plugs (set)	69 B20009
10	CF key (clear function) <b>CF</b>				
11	On/off key <b>Ⓜ</b> (standby)				
12	Weight display				

# BP 16000 S, BP 12000 S, BP 34000 P, BP 34

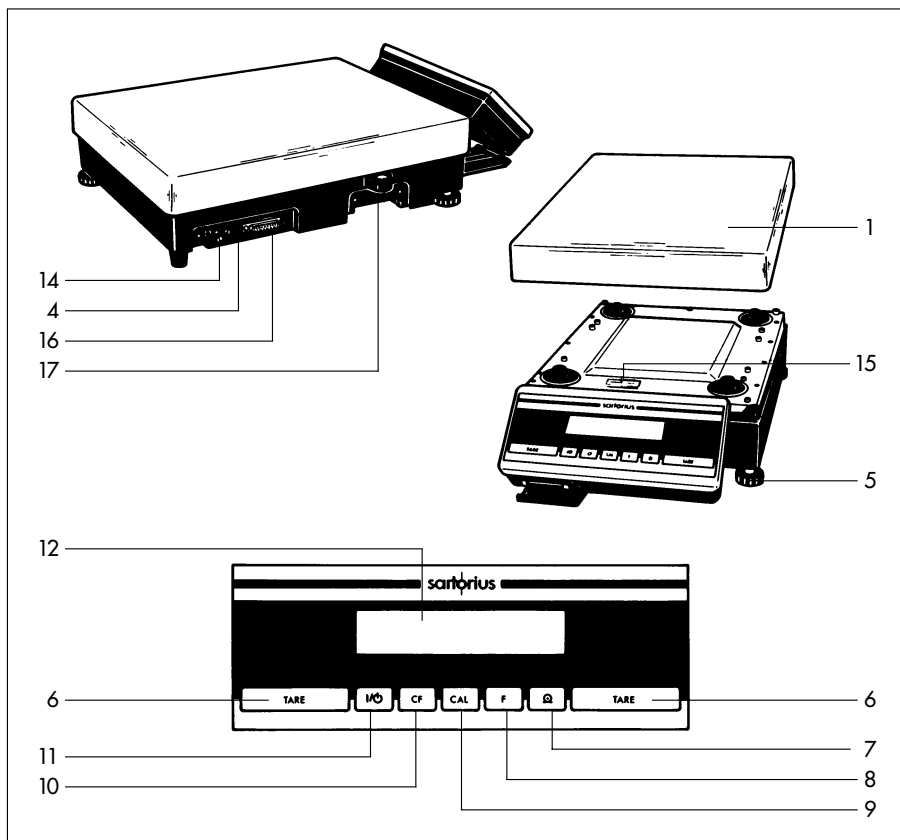

No. Designation	Order no. for replacement	No. Designation	Order no. for replacement
1 Weighing pan	69 LC0107	12 Weight display	
4 Menu access switch		14 DC jack	
5 Leveling foot	69 LC0092	15 Manufacturer's label with the <b>CE</b> mark of conformity	
6 Zero-setting and tare keys <b>TARE</b>		16 Data interface port	
7 Print key (data output) <b>Q</b>		17 Level indicator	
8 Function key <b>F</b>		Not shown:	
9 Adjustment/calibration key <b>CAL</b>		Plug for menu access switch	69 I31113
10 CF key (clear function) <b>CF</b>			
11 On/off key <b>ON/OFF</b> (standby)			

Please read through these installation and operating instructions carefully before operating your new balance.

### **Warranty**

Do not miss out on the benefits of our full warranty. Please complete the warranty registration card, indicating the date of installation, and return the card to your Sartorius office or dealer.

### **Storage and Shipping Conditions**

Allowable storage temperature: +5°C...+40°C  
+41°F...+104°F

In case there is any visible damage, proceed as directed in the section entitled "Safety Inspection."

**Save the box and all parts of the packaging for any future shipment of your balance as only the complete original standard packaging ensures safe transport. Before packing your balance, unplug all connected cables to prevent damage.**

Do not expose the balance unnecessarily to extreme temperatures, moisture, shocks, blows or vibration.

# Installation Instructions

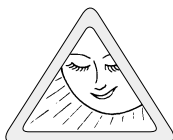

## Ambient Conditions

When choosing a location to set up your balance, observe the following:

- Set up the balance on a stable, even surface (benchtop or floor), or place it on a wall console (see “Accessories”)
- Avoid placing the balance in close proximity to a heater or otherwise exposing the balance to extreme heat or to direct sunlight
- Protect the balance from drafts that come from open windows and doors
- Avoid exposing the balance to extreme vibrations during weighing
- Protect the balance from aggressive chemical vapors
- Do **not** operate the balance in a hazardous area/location

Do not expose the balance to extreme moisture over long periods. Moisture in the air can condense on the surfaces of a cold balance whenever it is brought to a substantially warmer place. If you transfer the balance to a warmer area, make sure to condition it for about 2 hours at room temperature, leaving it unplugged from AC power. Afterwards, keep the balance connected continuously to AC power.

### **Using Verified Balances as Legal Measuring Instruments in the EU\***

You must calibrate the balance at the place of installation before using it as a legal measuring instrument (see the section entitled "Adjustment/Calibration" starting on page 22).

This balance is not allowed to be used for weighing goods intended for direct sale to the public. The type-approval certificate for verification applies only to non-automatic weighing instruments. For balances of accuracy class **(I)**, a thermometer and barometer are recommended for monitoring ambient conditions. The temperature range indicated on the verification ID label must not be exceeded during operation.

The balance must warm up for at least 24 hours after initial connection to AC power.

\* = including the Signatories of the Agreement on the European Economic Area

# Getting Started

- Remove the plastic wrapping, adhesive tape and styrofoam from the balance.

Control Seals on Verified Balances Approved for Use as Legal Measuring Instruments in the EU\* :

Legal regulations require the verified balance to be sealed. This control seal consists of an adhesive label with the name "Sartorius" on it. This seal will be irreparably damaged if you attempt to remove it. In this case, the validity of the seal becomes void and you must have your balance re-verified.

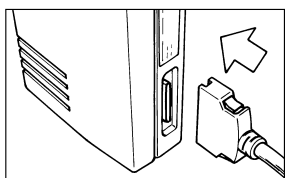

## Connecting the BP 211 D (-OCE) Balance to the Electronics Box:

- Plug the cable into the socket of the electronics box.

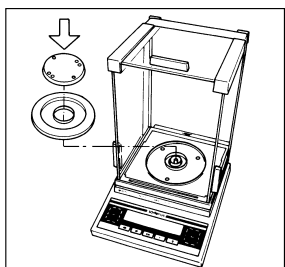

## Preparing the Weighing Chamber for Balances with an Analytical Draft Shield Chamber

Place the components listed below inside the chamber in the order given:

- Shield ring (2)
- Weighing pan (1)

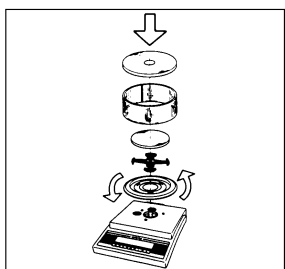

## Preparing Balances with a Round Glass Draft Shield

- Place the shield disk (2) on the balance. Turn the disk counterclockwise until it stops and is secured.

Place the components listed below on the balance in the order given:

- Pan support (21)
- Weighing pan (1)
- Glass draft shield cylinder (20)
- Draft shield cover (19)

\* = including the Signatories of the Agreement on the European Economic Area

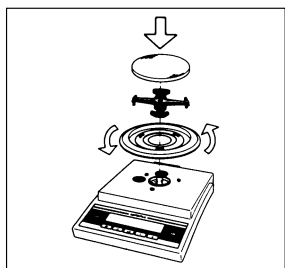

### Preparing Balances with a Round Weighing Pan

- Place the shield disk **(2)** on the balance. Turn the disk counterclockwise until it stops and is secured.

Place the components listed below on the balance in the order given:

- Pan support **(21)**
- Weighing pan **(1)**

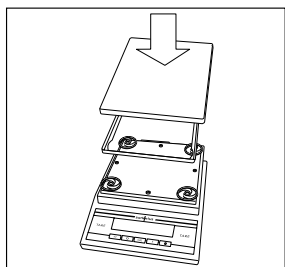

### Preparing Balances with a Rectangular Weighing Pan

Place the components listed below on the balance in the order given:

- Pan shield (only for model BP4100 S-OCE or the option YDS02BP)
- Weighing pan **(1)**

## Connecting the Balance to AC Power

The balance is powered by an AC adapter. Make sure that the voltage rating printed on this unit is identical to your local line voltage.

If the voltage specified on the label or the plug design of the AC adapter does not match the rating or standard you use, please contact your dealer. The AC adapters have IP 20 protection in accordance with DIN VDE 0470/EN 60529.

### Important Note:

Use only original adapters. Use of AC adapters from other manufacturers, even if these units have a registered approval rating from a national testing laboratory, requires the consent of an authorized service technician. To operate the balance using an external rechargeable battery pack or an industrial power supply (IP 65), see "Accessories."



**Plug the cord of the AC adapter into the balance as follows:**

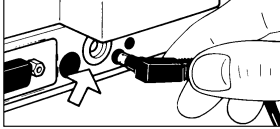

– Use the DC jack (14) for balances with a weighing capacity of < 10 kg

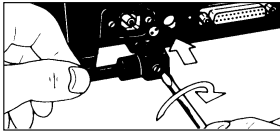

– Use the DC jack (14) for balances with a weighing capacity of  $\geq 10$  kg  
Insert the right-angle plug into the jack as shown in the diagram on the left; then tighten the screw.

**Then insert the plug of the AC adapter into a wall outlet (mains).**

### **Voltage Selection**

(does not apply to balances with a weighing capacity of  $\geq 12$  kg)

You can select the voltage only if you use our portable power supply (6971172) that has a European-type plug (rounded prongs).

### **Safety Precautions**

The AC adapter rated to Class 2 can be plugged into any wall outlet without requiring any additional safety precautions. The ground terminal is connected to the balance housing, which can be additionally grounded for operation. The data interface is also electrically connected to the balance housing (ground).

### **Information on Radio Frequency Interference**

Note:

This equipment has been tested and found to comply with the limits for a Class A digital device, pursuant to Part 15 of the FCC Rules. These limits are designed to provide reasonable protection against harmful interference when the equipment is operated in a commercial environment. This equipment generates, uses, and can radiate radio frequency energy and, if not installed and used in accordance with the instruction manual, may cause harmful interference to radio communications. Operation of this equipment in a residential area is likely to cause harmful interference, in which case the user will be required to correct the interference at his own expense. Changes or modifications not expressly approved by Sartorius AG could void the user's authority to operate the equipment.

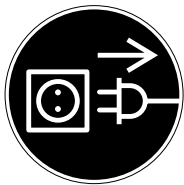

### Connecting Electronic Peripheral Devices

Make absolutely sure to unplug the balance from AC power before you connect or disconnect a peripheral device (printer or PC) to or from the interface port.

### Adjusting the Display Unit on Balances with a Weighing Capacity of $\geq 10$ kg

Adjust the display unit to the position desired.

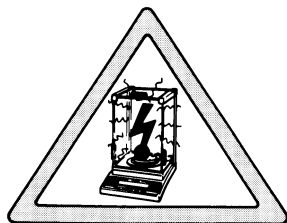
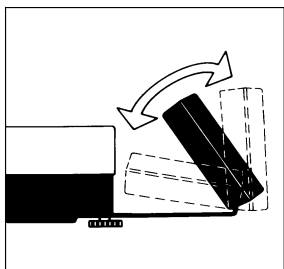

### Information on Weighing Electrostatically Charged Samples

If static electricity from the sample or container is interfering with the weighing procedure (causing unstable readouts), use an antistatic pan instead of the standard weighing pan when weighing on balances with a readability of 0.1 mg (see "Accessories").

## Leveling the Balance Using the Level Indicator

At the place of installation, level the balance using the leveling feet (5) so that the air bubble is centered within the circle of the level indicator (17).

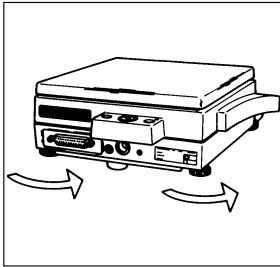

For balances with a rectangular pan and a weighing capacity of <math>< 10\text{ kg}</math>:

Retract the two auxiliary feet located at the back of the balance.

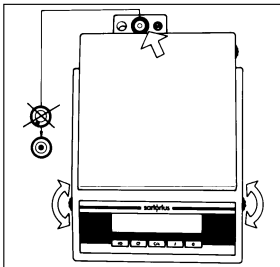

Use the level indicator as a guide to level the balance as follows:

To lift the balance, extend the front leveling feet (turn clockwise).

To lower the balance, retract the front leveling feet (turn counterclockwise).

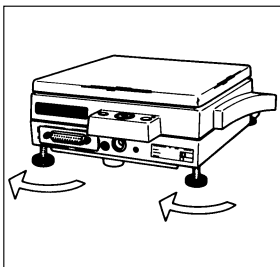

For balances with a rectangular pan and a weighing capacity of <math>< 10\text{ kg}</math>:

After retracting the rear auxiliary feet, extend them until they touch the surface on which the balance rests.

# Operating the Balance

## Warmup Time

To deliver exact results, the balance must warm up for at least 30 minutes after connection to AC power or after a power outage. Only after this time will the balance have reached the required operating temperature.

## Turning the Display On and Off (Standby Mode)

Press the  key (11) to turn the display on and off.

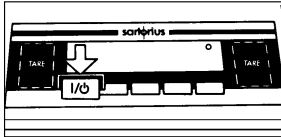

## Self-Test

After the balance has been turned on, an automatic self-test of the balance's electronic circuitry is performed. At the end of the self-test, a zero readout is displayed. This means that the balance is ready to operate.

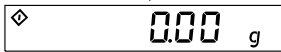

## Important Note Concerning Verified Balances Approved for Use as Legal Measuring Instruments in the EU\*:

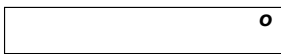

The last digit on the display is bordered when the verification scale interval "e" is greater than the scale interval "d."

The display shows the following special codes for your information:





 displayed in the upper right corner stands for **OFF**. The balance was disconnected from AC power (balance reconnected to AC power or power outage longer than 3 seconds).



 displayed in the lower left corner means **standby**. The display has been turned off by the  key (11). The balance is now in the ready-to-operate mode and does not require warmup.



 means **busy**. Once you have turned on the balance, the  symbol will be displayed until you press a key. During operation, this symbol indicates that the balance processor is still busy processing a function and will not accept another command to perform any other functions at this time.

\* = including the Signatories of the Agreement on the European Economic Area

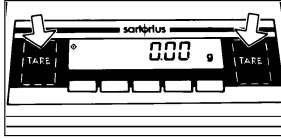

## Taring

A weight can be determined accurately only from a defined zero point. Press one of the **TARE** keys (6) to zero the weight display. You can tare within the entire weighing range of the balance.

### Important Note Concerning Verified Balances Approved for Use as Legal Measuring Instruments in the EU\*:

The symbol **-0-** in the weight display (on the left) shows that the balance is exactly tared to "Zero" ( $\pm 0.25$  of a scale interval).

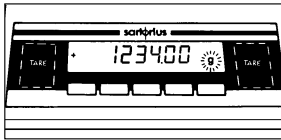

## Simple Weighing (Weight Determination)

Place your sample on the weighing pan (1) to determine the weight. Read off the weight indicated on the display only after the weight unit "g" or a different unit selected appears as the stability symbol. You can find more information on the weight units on page 33 under "Weight Units."

### Important Note Concerning Verified Balances of Accuracy Class (I)

To avoid measuring errors, the respective air density must be allowed for. The following formula is used to calculate the mass of the sample:

$$m = n_w \frac{1 - \rho_l / 8000 \text{ kg m}^{-3}}{1 - \rho_l / \rho}$$

$m$  = mass of the sample

$n_w$  = weight readout

$\rho_l$  = air density during weighing

$\rho$  = density of the sample

\* = including the Signatories of the Agreement on the European Economic Area

# Calibration/Adjustment

During calibration<sup>1)</sup>, the span of the balance is adjusted to the changes in ambient conditions.

You must adjust or calibrate your new balance at the place of installation after each warmup period and before the first measurement. You must also re-adjust or recalibrate your balance each time you set it up in a different area or when ambient conditions change (especially the temperature). Verified balances approved for use as legal measuring instruments must be adjusted/calibrated at least once a day.

The balance offers you various adjustment and calibration functions. You can select these functions by setting the appropriate menu codes. For more information, refer to "Balance Operating Menu."

You can interrupt any adjustment or calibration function by pressing **[CF]** (10).

## Using Verified Balances as Legal Measuring Instruments in the EU\*:

Before using your balance as a legal measuring instrument, you must carry out an "Internal Calibration" operation at the place of installation after the warmup period.

### Internal Calibration for Balances with a Built-in Calibration Weight

Menu code selection: 1 9 3\*\*

When the display shows a zero readout, press the **[CAL]** key (9) to activate the calibration function.

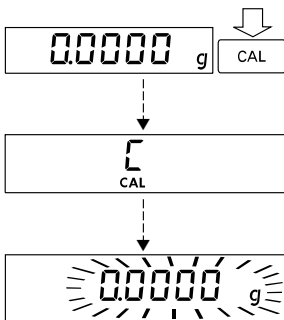

<sup>1)</sup> "Calibration" technically means to determine the difference between the balance readout and the actual weight on the pan to determine the accuracy. Adjustment means to bring a balance into the state of accuracy required for its use. Therefore, "calibration," as used in this manual, actually means "adjustment."

\* = including the Signatories of the Agreement on the European Economic Area

\*\* = factory setting for standard balances with a readability of  $\leq 0.1$  mg and for verified balances approved for use as legal measuring instruments in Europe.

The built-in calibration weight is internally applied by servomotor and removed at the end of adjustment or calibration.

If any interference affects the calibration procedure, you may obtain a brief display of the error code "Err 02."

In this case, tare and press the **[CAL]** key again.



### Important Note

During calibration, the weighing pan must be unloaded.

### External Calibration\*\*

Menu code selection – for standard balances: 1 9 1\*  
– for verified balances: 1 9 7

Use only calibration weights with nominal mass values and tolerances equal to or better than the accuracy class specified for your balance. You can find an overview of the calibration weight sets under "Accessories."

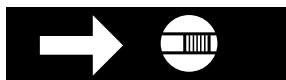

### Unlocking the Access Switch on Verified Balances of Accuracy Class (I):

- Remove the protective cap from the menu access switch **(4)** on the rear panel of the computing device.
- Move the menu access switch **(4)** in the direction of the arrow.

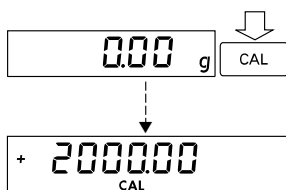

When a zero readout is displayed, press the **[CAL]** key **(9)**. This starts calibration. The calibration weight in grams is then displayed.

Errors or interference at the start of the calibration routine are indicated by the error code "Err 02." If this is the case, tare and press the **[CAL]** key again when a zero readout appears.

\* = factory setting on standard balances with a readability of  $\geq 1$  mg

\*\* = not applicable to verified precision balances of accuracy class (II)

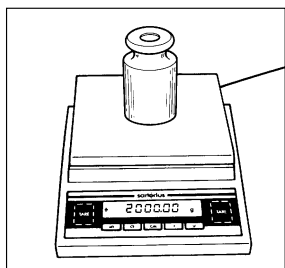

Center the calibration weight on the weighing pan. The balance then calibrates automatically. At the end of calibration, the calibration weight readout and the stability symbol "g" are displayed.

## Calibration Test for Balances with a Built-in Calibration Weight

Menu code selection: 1 9 4

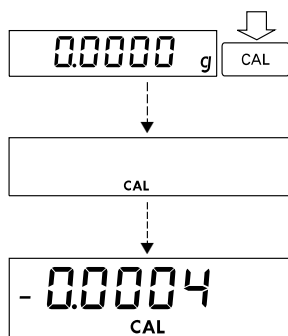

When a zero readout is displayed, press the **[CAL]** key (9). The built-in calibration weight is now internally applied by servomotor. At the same time, **CAL** is displayed. After the display has stabilized, the deviation of the current readout from the target weight (in grams only) is indicated.

If external interference affects the calibration test, you may obtain a brief display of the error code "Err 02." In this case, tare; then press the **[CAL]** key again.

## Blocking the Calibration/Adjustment Functions

You can block these functions by setting code 1 9 7 (when the menu access switch (4) is locked).

## Interface Port

Depending on the balance model, unfasten or remove the protective cap from the data interface port.

- Plug the connector into the interface port
- Secure the connector by tightening the screws

To print or output data, press the **[Q]** key (7).

## Important Note

Make absolutely sure to unplug the balance from AC power before you connect or disconnect a peripheral device (printer or PC) to or from the interface port.

For information about the data output parameters and data ID codes, see page 36.

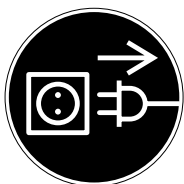
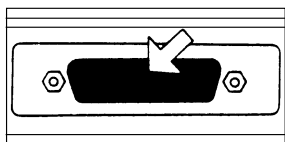



## Below-Balance Weighing

A port for a below-balance weighing hanger is located on the bottom of the balance (for balances with a weighing capacity of  $\geq 10$  kg, see "Accessories").

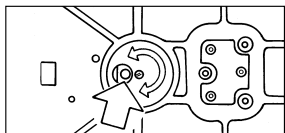

### For Balances with an Analytical Draft Shield Chamber:

To hook a sample on the hanger, open the below-balance port by turning the cover plate.

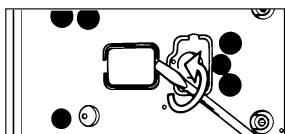

### For Precision Balances (Weighing Capacity of $< 10$ kg):

To open the below-balance port, remove the cover plate from the bottom of the balance.

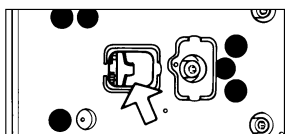

Now you can attach a sample using a suspension wire, for example. Common applications for below-balance weighing include density determination and immersing a sample in a special atmosphere (medium for reaction).

### Important Note Concerning Verified Balances Approved for Use as Legal Measuring Instruments in the EU\*:

The below-balance weighing port may not be opened or used when an approved balance is being operated as a legal measuring instrument.

### Important Note

When you use the below-balance weighing hanger, you must install a shield for protection against drafts.

### Fastening an Antitheft Locking Device\*\*

To fasten an antitheft locking device, use the lug (18) located on the rear panel of the balance.

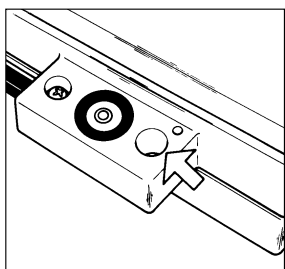

\* = including the Signatories of the Agreement on the European Economic Area

\*\* = not on BP 211 D, BP 301 S, BP 221 S, BP 161 P, BP 121 S, BP 61 S (-OCE), BP 16000 S, BP 12000 S, BP 34000 P, BP 34

# Troubleshooting Guide

Problem	Causes	Solution
No segments appear on the weight display <b>(13)</b>	<ul style="list-style-type: none"> <li>- No AC power is available</li> <li>- The AC adapter is not plugged in</li> </ul>	<ul style="list-style-type: none"> <li>- Check the AC power supply</li> <li>- Plug in the AC adapter</li> </ul>
No segments appear on the weight display after calibration/adjustment	<ul style="list-style-type: none"> <li>- The surface on which the balance rests is not stable</li> <li>- The balance has not yet internally stabilized</li> </ul>	<ul style="list-style-type: none"> <li>- Make sure that the ambient conditions are stable</li> <li>- Prevent vibrations from affecting the surface on which the balance rests</li> <li>- Close the draft shield</li> </ul>
The weight display shows "H"	<ul style="list-style-type: none"> <li>- The load exceeds the capacity of the balance</li> </ul>	<ul style="list-style-type: none"> <li>- Unload the balance</li> </ul>
The weight display shows "L" or "Err 54"	<ul style="list-style-type: none"> <li>- The weighing pan <b>(1)</b> is not in place</li> </ul>	<ul style="list-style-type: none"> <li>- Position the pan</li> </ul>
"Err 235" on the BP 211 D (-OCE)	<ul style="list-style-type: none"> <li>- Cable not connected properly</li> <li>- Electronics box taken from another balance model</li> </ul>	<ul style="list-style-type: none"> <li>- Plug in the cable correctly</li> <li>- Make sure components are appropriately connected</li> </ul>
The weight readout changes constantly	<ul style="list-style-type: none"> <li>- Too much vibration, or the balance is exposed to a draft</li> <li>- The draft shield is not completely closed</li> <li>- A foreign object is caught between the pan and the balance housing</li> <li>- The below-balance weighing port is open</li> <li>- The sample does not have a stable weight (absorbs moisture or evaporates)</li> <li>- The sample is electrostatically charged</li> </ul>	<ul style="list-style-type: none"> <li>- Access the menu to select the correct code for the weighing environment</li> <li>- Close the draft shield</li> <li>- Remove the foreign object</li> <li>- Close the port for below-balance weighing</li> </ul>
The weight readout is obviously wrong	<ul style="list-style-type: none"> <li>- The balance has not been calibrated</li> <li>- The balance was not tared before weighing</li> </ul>	<ul style="list-style-type: none"> <li>- Calibrate the balance (see page 22)</li> <li>- Tare before weighing</li> </ul>

# Care and Maintenance

## Servicing

Regular servicing of your balance by a Sartorius technician will ensure its continued weighing accuracy. Sartorius can offer you service contracts with your choice of regular maintenance intervals ranging from 1 month to 2 years.

## Cleaning

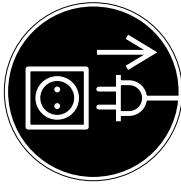

Before cleaning the balance, unplug the AC adapter from the wall outlet (mains supply).

Please do not use any aggressive cleaning agents (solvents or similar agents). Instead, use a piece of cloth which has been wet with a mild detergent (soap). Make sure that no liquid enters the balance housing. After cleaning, wipe down the balance with a soft, dry piece of cloth.

Carefully remove any sample residue/spilled powder by using a brush or a hand-held vacuum cleaner. Make sure that no liquid or dust enters the crevice surrounding the pan adapter.

## Safety Inspection

If there is any indication that safe operation of the balance with the AC adapter is no longer warranted, turn off the power and disconnect the equipment from AC power immediately. Lock the equipment in a secure place to ensure that it cannot be used for the time being.

Safe operation of the balance with the AC adapter is no longer ensured when

- there is visible damage to the AC adapter
- the AC adapter no longer functions properly
- the AC adapter has been stored for a relatively long period under unfavorable conditions

In this case, notify your nearest Sartorius Service Center Unit. Only service technicians who are authorized by Sartorius and who have access to the required maintenance manuals are allowed to perform maintenance and repairwork on the equipment.

# Balance Operating Menu

In the operating menu, you can define how your balance will adapt to ambient conditions and also how it will work to meet your special requirements.

## Changing Menu Code Settings

To select specific functions, you will need to set the respective menu codes.

The keys have special functions for setting menu codes:

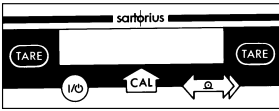

- CAL (9)** = Increases a number by one with each press (the numbers change in cycles)
- TARE (6)** = Confirms and stores a code setting; and exits the menu
- ⏏ (7)** = Moves to the next of the three numbers of a code (1st-2nd-3rd-1st, etc.)

The code for "automatic power-on" is **8 5 4**.

## Accessing the Menu (Example: Code 8 5 4)



- Press **I/O** to turn off the balance.
- Turn the balance back on. While all segments are displayed, briefly hold down **TARE**.

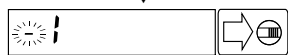

- For standard balances, if “-” is displayed next to the left-hand number, proceed as follows to unlock the menu:

- For balances with a weighing capacity of < 10 kg, remove the protective cap and move the menu access switch **(4)** in the direction of the arrow.
- For balances with a weighing capacity of  $\geq 10$  kg, remove the larger-threaded cap located on the right next to the DC jack and move the menu access switch **(4)** in the direction of the arrows.

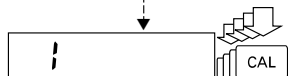

- Press **CAL** several times until “8” appears.

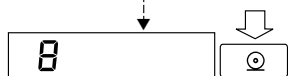

- Press **⊙** until the 2nd number of the code appears.

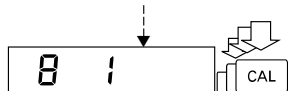

- Press **CAL** until “5” appears.

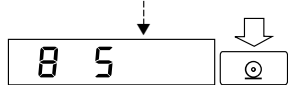

- Press **⊙** until the 3rd number appears (when you move to the third number, the previously set menu code will appear).

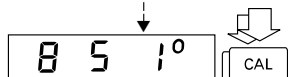

- Press **CAL** to select “4.”

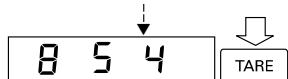

### - Confirming a Menu Code Setting

Press a **TARE** key to confirm the code you have just set (this is indicated by the “o” after the code).

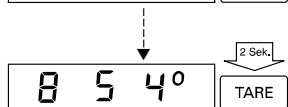

- To **store** the new menu code setting, press one of the **TARE** keys **for more than 2 seconds!**

The current code setting in the balance operating menu is identified by a small, superscript “o” after the last number. When you access the operating menu, the previously set code will be displayed after you have selected the right-hand number, which means the entire menu code setting will be displayed. This makes it easy for you to check the previously set menu codes.

If you would like to change several menu code settings, you do not have to press a [TARE] key after each change to exit the balance operating menu. You can also confirm individual settings.

**Important Note Concerning Standard Balances:** Please do not forget to relock the balance operating menu to avoid inadvertent changes to the settings. The symbol “-” indicates that the menu is locked.



**Important Note Concerning Verified Balances Approved for Use as Legal Measuring Instruments in the EU\*:**

The balance operating menu on verified balances cannot be locked with the menu access switch (“-” not displayed).

**Exiting the Menu without Storing Code Changes**

Changes to the code settings are not stored if you turn off the balance by pressing [ON] while selecting the code numbers or before pressing [TARE] to save a setting.

**Undoing All Menu Code Changes – Reset Function**

The reset function lets you undo all menu code changes, which means that you will obtain the original factory-set menu codes identified by an “\*.” To use this function, select code 9 -- 1°. See the previous page for information on confirming and storing a menu code setting.

Reset function	Code
On	9 -- 1
Off	9 -- 2

\* including the Signatories of the Agreement on the European Economic Area

# Balance Operating Parameters

## Adapting the Balance to Ambient Conditions

The balance can be adapted to the prevailing ambient conditions at the place of installation.

	Code		
Very stable conditions	1	1	1*
Stable conditions	1	1	2*
Unstable conditions	1	1	3
Very unstable conditions	1	1	4

## Standard Weighing Mode – Manual Filling Mode

You can optimally adapt your balance to meet either of these requirements. In the manual filling mode, the display compensates for fluctuations of the load on the balance, giving you especially fast and stable readouts.

	Code		
Standard weighing mode	1	2	1*
Manual filling mode	1	2	2

## Stability Range

The stability symbol will remain displayed in the case of a weight variation +/-

	Code		
0.25 digit	1	3	1
0.5 digit	1	3	2*
1 digit <sup>1)</sup>	1	3	3
2 digits <sup>1)</sup>	1	3	4*
4 digits <sup>1)</sup>	1	3	5
8 digits <sup>1)2)</sup>	1	3	6

\* = factory setting; depends on the balance model in some cases

<sup>1)</sup> = not applicable to the BP 8-OCE and BP 2100-OCE

<sup>2)</sup> = not applicable to the verified balances approved for use as legal measuring instruments in the EU

## Tare Parameter

You can define when the balance will perform the taring operation:

	Code**
At any time	1 5 1
Not until the readout is stable	1 5 2*

## Auto Zero Function

When this zero-tracking function is activated, any slight changes off the zero readout are automatically tared.

	Code
Auto Zero on	1 6 1*
Auto Zero off	1 6 2

## Adjustment/Calibration and Linearization Functions Using CAL

Internal Linearization applicable only to the BP 211 D, 301 S (-OCE)

	Code
External calibration	1 9 1*/**
Internal calibration for balances with a built-in automatic calibration function	1 9 3*
Calibration test for balances with a built-in automatic calibration function	1 9 4
Internal linearization with automatic calibration	1 9 6
Adjustment/calibration functions blocked	1 9 7

### Important Note Concerning Verified Balances Approved for Use as Legal Measuring Instruments in the EU:

For verified balances of accuracy class (II), the menu access switch is adjusted to lock the "External Linearization" function after verification, and a control seal is affixed to the balance to lock the menu access switch.

\* = factory setting; depends on the balance model in some cases

\*\* = setting not applicable to verified balances of accuracy class (II)



# Weighing Using Two Weighing Units

The **[F]** key **(8)** lets you toggle back and forth between two weight units.  
The 2nd unit is identified by the display symbol "R1."

	Code
<b>[F]</b> key blocked	2 1 1*
Mass unit conversion by toggling	2 1 2

## General View – Weight Units

	Symbol/Conversion factor		Code			
	1 g =		1st level		2nd level R1	
Grams (o)**	o	1.	1	7	1	3 1 1
Grams	g	1.	1	7	2*	3 1 2*
Kilograms <sup>1)</sup>	kg	0.001	1	7	3*	3 1 3*
Carats**	ct	5.	1	7	4	3 1 4
Pounds**	lb	0.0022046226	1	7	5	3 1 5
Ounces**	oz	0.035273962	1	7	6	3 1 6
Troy ounces**	ozt	0.032150747	1	7	7	3 1 7
Hong Kong taels**	tl (thl) <sup>3)</sup>	0.02671725	1	7	8	3 1 8
Singapore taels**	tl (ths) <sup>3)</sup>	0.02646063	1	7	9	3 1 9
Taiwanese taels**	tl (tht) <sup>3)</sup>	0.02666666	1	7	10	3 1 10
Grains**	GN	15.43235835	1	7	11	3 1 11
Pennyweights**	dwt	0.643014931	1	7	12	3 1 12
Milligrams <sup>2)</sup>	mg	1000.	1	7	13	3 1 13*
Parts per pound**	o (/lb) <sup>3)</sup>	1.1287667712	1	7	14	3 1 14
Chinese taels**	tl (thlc) <sup>3)</sup>	0.02645547175	1	7	15	3 1 15
Mommes**	m (mom) <sup>3)</sup>	0.2667	1	7	16	3 1 16
Carats**	k (K) <sup>3)</sup>	5.	1	7	17	3 1 17
Tola**	t (tol) <sup>3)</sup>	0.0857333381	1	7	18	3 1 18
Baht**	b (bat) <sup>3)</sup>	0.06578947436	1	7	19	3 1 19
Mesghal**	m (MS) <sup>3)</sup>	0.217	1	7	20	3 1 20

\* = factory setting; depends on the balance model in some cases

\*\* = not applicable to verif. balances approved for use as legal meas. instruments

1) = not applicable to verified balances of accuracy class **(I)**

2) = not applicable to verified balances of accuracy class **(II)**

3) = unit symbols output via the data interface

## Display Modes

You can select the display mode that best meets your individual accuracy requirements (last numeral). The display increments possible are as follows: 1, 2, 5, 10, 20, 50, etc.

Starting with the basic increments of a weight unit, the display accuracy can be reduced by as many as three levels so that you will obtain a faster readout with a reduced display accuracy. The display accuracy is reduced proportionally to the selected basic increment of a weight unit. To make this concept easier to understand, the three levels are designated as "rounding factors" in the tables summarizing the various menu code settings.

Display mode	Code					
	1st level			2nd level R1		
Highest possible accuracy	1	8	1*	3	2	1*
Last numeral blanked when load changes <sup>1)</sup>	1	8	2	3	2	2
Rounding factor 2**	1	8	3	3	2	3
Rounding factor 5**	1	8	4	3	2	4
Rounding factor 10** (last numeral off)	1	8	5	3	2	5

\* = factory setting

\*\* = not applicable to verified balances approved for use as legal measuring instruments in the EU

<sup>1)</sup> = applicable only to verified balances approved for use as legal measuring instruments in the EU

# Interface Parameter Settings

Baud Rate	Code
150 baud	5 1 1
300 baud	5 1 2
600 baud	5 1 3
1,200 baud	5 1 4*
2,400 baud	5 1 5
4,800 baud	5 1 6
9,600 baud	5 1 7
19,200 baud	5 1 8

Parity	Code
Mark	5 2 1
Space	5 2 2
Odd	5 2 3*
Even	5 2 4

Number of Stop Bits	Code
1 stop bit	5 3 1*
2 stop bits	5 3 2

Handshake Mode	Code
Software handshake	5 4 1
Hardware handshake with 2 characters after CTS	5 4 2*
Hardware handshake with 1 character after CTS	5 4 3

\* = factory setting

## Utilities for Printouts or Data Transfer

Sartorius balances come standard with an interface. You can plug a Sartorius printer or a computer into this interface port. In addition, you can choose to have data output from your balance to this on-line device either automatically or by pressing the [Ⓞ] key.

The balance operating menu lets you define the various parameters for data output. Information on the data formats and for interfacing a computer or a different peripheral device are available on request.

### Data Output Parameter

This parameter is coupled with the stability parameter

Print on request = data is output only when the [Ⓞ] key is pressed or a software command is received

Auto print = continuous, automatic data output

	Code
Print on request regardless of stability	6 1 1
Print on request after stability, with storage of the function	6 1 2*
Print on request at stability, without storage of the function	6 1 3
Auto print regardless of stability	6 1 4
Auto print at stability	6 1 5

### Auto Print

You can stop and start automatic data output (auto print function) by pressing the [Ⓞ] key.

	Code
Start/stop auto print using the [Ⓞ] key	6 2 1
Auto print not stoppable	6 2 2*

### Data Output at Defined Intervals

The menu code for "2 display updates" must be set if you connect the remote display to the balance.

	Code
1 display update	6 3 1*
2 display updates	6 3 2

\* = factory setting

### Automatic Taring after Data Output (Print on Request)

This convenient setting lets you checkweigh a series of samples or products without having to unload the balance after each weighing operation.

- the sample remains on the pan after the weight readout has been printed or transferred to an on-line computer
- the balance is tared automatically after the weight readout has been printed or transferred to an on-line computer
- you simply load the next sample or part

	Code
Data output without automatic taring	6 4 1*
Data output with automatic taring	6 4 2

### Automatic Output of the Application Parameters

After completing an application started by pressing the **[F]** key, you can have the application parameters and results printed out or transferred to an on-line computer.

	Code
Off	7 1 1*
On	7 1 2

### Data ID Codes

To help you identify weights, piece counts, percentages, etc., a code letter is printed or displayed in front of these values. For example, an "N" printed or displayed in front of a weight value identifies it as a net weight. If you set the code for "without data ID code," only net weights, results in percent and counting results will be output. You will find the data ID codes for a particular application program listed in the corresponding description.

The ID code increases the data output format for each weight readout from 16 to 22 characters.

ID code for data output	Code
Without	7 2 1*
With	7 2 2

\* = factory setting

## Automatic Output of the Tare Memory Data

If you have selected the application program "tare memory" (2 1 6), you can have your choice of values output by pressing the **[F]** key:

	Code
Last net value (individual value N1)	7 3 1*
Tare memory data (total T1)	7 3 2

## Additional Functions

### Menu Access Switch Function on Standard Balances

You can define the function of the menu access switch by setting the code for the balance operating menu to "accessible." The balance operating menu will then be accessible at all times, which means that you can change the menu codes at any time regardless of the setting of the menu access switch.

Access to the balance operating menu	Code
Accessible	8 1 1
Depends on the setting of the menu access switch	8 1 2*

### Menu Access Switch Function on Verified Balances

The balance operating menu can also be changed when the balance is being used as a legal measuring instrument. Codes that are not permitted for operation of the balance as a legal measuring instrument are blocked and cannot be selected. For balances of accuracy class (II), the menu access switch is adjusted to lock the "External Calibration" function after verification. To do this, the switch must be moved to the left. A control seal is affixed to the balance to lock the menu access switch. Unauthorized attempts to remove this seal will irreversibly damage it. If you break the seal, the validity of the verification will become void, and you must have your balance re-verified.

### Blocking the Keys





You can block all keys on the balance (except for **[I/O]**).

Key functions	Code
Accessible	8 3 1*
Blocked	8 3 2

\* = factory setting

## Universal Switch for Remote Control

You can connect an external universal switch to the interface port of your balance for remote control of the functions listed below.

Functions	Code
Print 	8 4 1*
Tare 	8 4 2
Adjust/calibrate/linearize (using  )	8 4 3
 key	8 4 4
 key	8 4 5



## Power-On Mode

Depending on your requirements, you can change the power-on mode of your balance.

The factory setting is: (power) off → on ↔ standby.

In this default setting, when you press the  key (11) to turn off the display, the balance will remain in the standby mode. This means that it will be ready to operate without requiring any warmup when you turn the display back on.

In the setting “Toggle between on and standby,” the balance will automatically turn on again after it has been temporarily disconnected from AC power or a power failure has occurred.

In the setting “Automatic power-on,” the balance will automatically turn on again after it has been temporarily disconnected from AC power, the  key has been pressed, or after a power failure has occurred. In this setting, you cannot use the  key to turn off the balance. If your balance is connected to a central power supply that is switched off overnight, the balance will turn on automatically the next day as soon as the power supply is switched on again.

Power-on mode	Code
(Power) off → on ↔ standby	8 5 1*
On ↔ standby	8 5 3
Automatic power-on	8 5 4

\* = factory setting

# Application Programs

In addition to the functions implemented for weighing, Sartorius Basic<sup>plus</sup> balances offer you a variety of application programs.

To select an application program or a specific function, set the appropriate code in the menu. The procedure for setting menu codes is described in detail starting on page 28.

## Using Verified Balances as Legal Measuring Instruments in the EU\*:

All application programs can be selected on balances used as legal measuring instruments. Non-metric values are indicated as follows:

Percent = %; Piece count (counting) = pcs; Computed value = o

## Tare Memory

### Tare Memory

Code 2 1 6

Symbol displayed when a value is stored: **NET**

Press the  F key (**8**) to store the tare weight. The balance is now automatically tared so you can weigh again starting with a zero readout.

### Practical Example: Tare – Net – Gross Weights

Menu code settings used in the example:

Function	Code
Tare memory	2 1 6
Automatic output of all parameters	7 1 2
With data ID code	7 2 2
Print tare memory	7 3 2

As an alternative, you can select this automatic output parameter:

Print net value	7 3 1**
-----------------	---------

\* = including the Signatories of the Agreement on the European Economic Area

\*\* = factory setting



**Application:** Obtaining printouts of tare, net and gross weights or outputting these data to a computer

Step/Key	Readout	Data Output/Printout
[CF], [TARE]	0.00 g	
Place container on pan [F]	+ 22.65 g 0.00 g NET	<b>T1 + 22.65 g</b>
Fill container with sample; press [Q]	+ 250.24 g NET	<b>N1 + 250.24 g</b>
[CF], [Q]	+ 272.89 g	<b>N + 272.89 g</b>
The data ID codes mean:		
<b>T1</b>	<b>+ 22.65 g</b>	tare weight stored in the memory (weight value)
<b>N1</b>	<b>+ 250.24 g</b>	net weight when tare weight is stored
<b>N</b>	<b>+ 272.89 g</b>	gross weight = tare + net

### Practical Example: Net Total

Menu code settings used in the example:

Function	Code	
Tare memory	2 1 6	As an alternative, you can select this output parameter:
Automatic data output	7 1 2	
With data ID code	7 2 2	
Printout of individual components/tare weights	7 3 1*	Printout of the net total weight/total tare weight 7 3 2

\* = factory setting

**Application:** Simple compounding and formulating of several components with additive storage, automatic taring and outputting of the component weights

Step/Key	Readout	Data Output/Printout
Place container on pan	+ 22.65 g	
<input type="button" value="CF"/> , <input type="button" value="TARE"/>	0.00 g	
Weigh in 1st component; store: <input type="button" value="F"/>	+ 4.61 g 0.00 g NET	<b>N1 + 4.61 g</b>
Weigh in 2nd component; store: <input type="button" value="F"/>	+ 60.33 g 0.00 g NET	<b>N1 + 60.33 g</b>
Weigh in and store additional components: <input type="button" value="F"/>	xxx.xx g NET	<b>N1 + xxx.xx g</b>
Finish weighing in components; output total weight: <input type="button" value="CF"/> , <input type="button" value="⊙"/>	+ 272.89 g	<b>N + 272.89 g</b>
The data ID codes	mean:	
<b>N1 + 60.33 g</b>	component weight (net individual weight)	
<b>N + 272.89 g</b>	total components weighed in (net total weight)	

## Weighing in Percent

### Weighing in Percent

Code 215

Symbol displayed: %

This application program enables you to obtain weight readouts in percent which are in proportion to a reference weight. The reference weight readout is stored as a menu-defined percentage (factory setting: 100%). After treating the sample, place it on the weighing pan and read off the weight in percent.

## Changing the Reference Percentage

You can change the reference percentage in cycles. Choose from the following settings: 5, 10, 20, 50 and 100.

To activate the change function:	Hold down <b>[F] (8)</b> for more than 2 seconds until "rEF 100 %" appears on the display
To change the setting:	Briefly press <b>[F]</b>
To store the percentage:	Hold down <b>[F]</b> for more than 2 seconds to store this value permanently (in the non-volatile memory) after you turn off the power

This setting is **not** canceled by the reset code 9 -- 1°!

## Storage Parameter for the Reference Weight/Value

The reference weight/value is stored ...	Code
with full accuracy according to the internal resolution	3 5 1*
according to the display accuracy	3 5 2

When you exit the reference storage mode, "Err 22" may briefly be displayed. This means that the new reference value has been stored.

## Toggle between the Readout in Percent (%) and Weight (g)

After placing the sample on the weighing pan, you can toggle between the readout in percent and the respective weight readout in grams by pressing the **[F]** key after you have stored the reference value. To clear the readout in percent, use the **[CF]** key.

## Display Parameter for Readouts in Percent

The following display parameters can be set for readouts in percent:

The readout in percent is displayed ...	Code
without a decimal place	3 6 1
with one decimal place	3 6 2*
with two decimal places	3 6 3*
with three decimal places	3 6 4

If the weight stored is too light to be displayed, the number of decimal places is automatically decreased.

\* = factory setting; depends on the balance model in some cases

## Practical Example: Determination of the Residual Weight in Percent

Menu code settings used in the example:

Function	Code
Weighing in percent	2 1 5
Ref. % and weight	7 1 2
With data ID code	7 2 2

**Application:** Quick determination of the dry weight of a sample

Step/Key	Readout	Data Output/Printout
Place container on pan	+ 22.65 g	
<b>CF</b> , <b>TARE</b>	0.00 g	
Add prepared sample to container; <b>F</b>	+ 4.61 g + 100.0%	<b>nRef</b> + 100 % <b>Wxx%</b> + 4.61 g
 For moisture analysis, press <b>TARE</b> at this point	0.0%	
Remove container; dry sample	xx.x%	
Reweigh sample in container	+ 72.5%	
<b>☉</b>	+ 72.5%	<b>Prc</b> + 72.5 %
Press <b>CF</b> to clear residual weight readout and reference value	+ 3.34 g	
<b>☉</b>	+ 3.34 g	<b>N</b> + 3.34 g

The data ID codes	mean:
<b>pRef</b> + 100 %	reference percentage
<b>Wxx%</b> + 4.61 g	net reference weight xx%
<b>Prc</b> + 72.5 %	calculated percentage
<b>N</b> + 3.34 g	net residual weight

# Counting

## Counting

Code 2 1 4

Symbol displayed: 

The counting program allows automatic conversion of weights into piece counts based on a reference sample weight. A weight readout is stored as a reference sample quantity (factory setting: 10 pcs = pieces). When you turn on the balance, the reference sample quantity will be displayed as "rEF 10 pcs" before you enter the piece count.

### Displaying the Reference Sample Quantity

You can have the reference sample quantity (pcs) setting displayed by pressing the **[F]** key when the balance is unloaded.

### Changing the Reference Sample Quantity

You can change the reference sample quantity in cycles. Choose from the following settings: 5, 10, 20, 50 and 100.

To activate the change function:	Hold down <b>[F] (8)</b> for more than 2 seconds until "rEF... pcs" appears on the display
To change the setting:	Briefly press <b>[F]</b>
To store the quantity:	Hold down <b>[F]</b> for more than 2 seconds to store this quantity permanently (in the non-volatile memory) after you turn off the power

This setting is **not** canceled by the reset code 9 -- 1°!

### Storage Parameter for the Reference Sample Weight

The reference weight is stored ...	Code
with full accuracy according to the internal resolution	3 5 1*
according to the display accuracy	3 5 2

When you exit the reference storage mode, "Err 22" may briefly be displayed. This means that the new reference value has been stored.

### toggling between the Piece Count (pcs) and Weight (g)

After placing the sample on the weighing pan, you can toggle between the piece count and the respective weight readout by pressing the **[F]** key.

\* = factory setting

## Practical Example: Counting Small Parts

Menu code settings used in the example:

Function	Code
Counting	2 1 4
Ref. qty. and ref. weight	7 1 2
With data ID code	7 2 2

**Application:** Counting bulk quantities of items with the same weight

Step/Key	Readout	Data Output/Printout
----------	---------	----------------------

Place container on pan + 22.65 g

,  0.00 g

Add 10 counted parts

Press  to confirm reference sample quantity

rEF	10 pcs	<b>nRef</b>	+	<b>10 pcs</b>
+	5.6546 g	<b>wRef</b>	+	<b>5.6546 g</b>
+	10 pcs			

Fill container with desired quantity of parts (without counting them)

+ 500 pcs

+ 500 pcs **Qnt** + **500 pcs**

Press  to clear the weight readout and the reference value

+ 2827.35 g

+ 2827.35 g **N** + **2827.35 g**

The data ID codes	mean:
<b>nRef</b> + <b>10 pcs</b>	reference sample quantity (piece count)
<b>wRef</b> + <b>5.6546 g</b>	reference weight
<b>Qnt</b> + <b>500 pcs</b>	calculated piece count
<b>N</b> + <b>2827.35 g</b>	net weight

# Animal Weighing/Averaging

## Animal Weighing/Averaging

Code 2 1 7

Symbol displayed: 

Use this program to determine the weights of live animals or weights under unstable ambient conditions. In this program, the balance calculates the weight as the average of a selectable number of individual weighing operations.

During averaging, the number of remaining individual subweighing operations is shown on the application display in a "countdown" mode.

Once all subweighing operations have been performed, the calculated mean value is indicated as a stable readout on the weight display.

### Manual or Automatic Start Mode

Depending on the menu code you select, animal weighing will be started automatically or manually by pressing a key.

If you select the "automatic mode," you will have to press **[F]** to start the program for averaging the first weight. You can press **[CF]** to interrupt a weight measurement in progress at any time. In the "automatic mode," the symbol "AUTO" will be displayed during weight measurement. The result is locked into the display. The  symbol or "AUTO" flashes during this time. The readout will stop flashing after you have unloaded the balance, and the next weight will be displayed.

Animal weighing/averaging will start by	Code
Manual mode	3 8 1
Automatic mode	3 8 2*

Once averaging has been completed, the program will stop until the balance is unloaded to half the value (50 display increments) of the storage threshold.

\* = factory setting

## Delayed Start Mode

A rule of thumb to go by for selecting the right setting to weigh animals is: the more active an animal is, the greater the difference must be between two successive subweights measured.

Depending on individual requirements, starting the averaging operation can be delayed either in the automatic or manual mode until the animal you are weighing has calmed down to a certain degree.

In this case, the start criterion is defined by the difference between two successive subweights measured. If the animal moves, the start criterion is not met; therefore, averaging will not start. Once the animal has calmed down, the program checks whether two measured subweights are within the previously selected range. If so, the actual averaging operation will be started.

Delay start until...	Code
difference is slight	3 7 1
difference is average	3 7 2*
difference is considerable	3 7 3

During averaging, the number of subweighing operations left to perform is shown on the weight display (countdown mode).

## Changing the Number of Subweighing Operations

You can change the number of subweighing operations used to average a weight. Change this number in cycles. You can choose from the following settings: 5, 10, 20, 50 and 100.

- |                                  |   |
|----------------------------------|---|
| To activate the change function: | Hold down <b>[F] (8)</b> for more than 2 seconds until "rEF 10" appears on the display  |
| To change the setting:           | Briefly press <b>[F]</b><br>If you enter a wrong number, press <b>[CF]</b> to clear it  |
| To store the number:             | Hold down <b>[F]</b> for more than 2 seconds to store this number permanently (in the non-volatile memory) after you turn off the power |

This setting is **not** canceled by the reset code 9 -- 1°!

\* = factory setting



## Storage Threshold for the Automatic Start Mode

To obtain an added measure of reliability in the automatic mode, in order to avoid an "incorrect start," a weight value must correspond to a minimum load of 100 display increments.

### Practical Example: Animal Weighing in the Automatic Start Mode

Menu code settings used in the example:

Function	Code	As an alternative, you can select this output parameter:
Animal weighing	2 1 7	
Delay start until dif. is average	3 7 2*	Other delay start 3 7 x
Automatic start mode	3 8 2*	Manual start mode 3 8 1
Automatic output of all parameters	7 1 2	
With data ID code	7 2 2	

**Application:** Automatic weighing of animals based on 10 subweighing operations

Step/Key	Readout	Data Output/Printout
Place animal weighing bowl on balance		
[CF], [TARE]	0.00 g	
Place 1st animal in bowl		
[F]	10 465.20 g	<b>mdef + 10</b> <b>x-Net + 465.20 g</b>
Remove 1st animal		
Place 2nd animal in bowl	10 388.53 g	<b>mdef + 10</b> <b>x-Net + 388.53 g</b>
Repeat above steps for all animals		
The data ID codes	mean:	
<b>mdef + 10</b>	defined number of subweighing operations	
<b>x-Net + 401.18 g</b>	calculated average	

\* = factory setting

# ISO/GLP-compliant Printout or Record

## Application:

Use of the balance as a test and measuring instrument in quality assurance systems in compliance with the requirements of ISO, GLP, GMP and EN (European Standards) in which proof of the balance's accurate performance is required. The balance can record all completed calibration or adjustment operations and print out data in compliance with the requirements of Good Laboratory Practice (GLP). The balance, interfaced with a data printer or a computer, creates a document that records the date, time, serial number and model number, making it possible to clearly trace data to the balance that generated it and the time at which it was generated.

**Select the ISO/GLP-compliant printout or record mode by setting the respective code in the balance operating menu:**

ISO/GLP-compliant printout/record mode	Code
Off	8 10 1*
Only for adjustment/calibration and linearization functions	8 10 2
Always on (e.g., for adjustment/calibration and linearization functions, application programs, weight readouts)	8 10 3

The following menu code setting must be selected in order to obtain an ISO/GLP-compliant printout/record:

With data ID code	7 2 2
-------------------	-------



### Important Note

ISO/GLP-compliant printouts/records will not be generated if the factory setting, code 7 2 1, is selected. In addition, do not select the "Auto print" data output parameter (code 6 1 4 or 6 1 5).

## Operating the Balance with a Device That Has an ISO/GLP Printing or Recording Capability

You can connect a special Sartorius Data Printer to Basic<sup>plus</sup> balances for generating ISO/GLP-compliant printouts (order no. YDPO3-OCE).

To generate ISO/GLP-compliant records with a computer, you will need special software. For information on writing this software, please ask Sartorius for a detailed description.

\* = factory setting

## Printout/Record for Adjustment or Calibration and Linearization Functions

A printout or record is generated at the end of the following functions:

- all calibration, adjustment and linearization procedures
- calibration test

The printout can have the following lines:

```
-----  
MC1 - Sartorius      : Balance family and manufacturer  
Model   BP211D      : Balance model  
S/N     040500048   : Serial number of the balance  
ID                                             : Space for entering the workstation or operator ID  
-----  
Date : 21-Mar-97    : Current date  
Start: 10:05:30     : Time at which the application started  
Cal.  : Extern      : Calibration mode (in this case,  
                    "external calibration")  
Set.  : 200.00000 g : Calibration weight value  
                    (only for "external calibration")  
End   : 10:05:45   : End of application  
Name  :             : Space for signature of the operator responsible  
-----
```

Additional information for other calibration modes:

```
Cal.  : Intern      : Internal calibration  
Stat. : Complete    : Status comment for calibration or linearization  
                    functions  
Cal.  : Test        : Calibration test  
Diff. :- 0.00004 g  : Data measured during calibration test
```

## Data Printout/Record (ISO/GLP-compliant)

To have a data record printed out, perform the following:

- Press **[⊙]** to output the printout heading and the first value (after you have turned on the balance or cleared a function by pressing **[CF]**)
- Press **[⊙]** to output additional data
- To end printout generation and recording of data, press **[CF]**

Generation of an ISO/GLP-compliant printout or record is also ended when an adjustment or calibration operation is started.

The printout can have the following lines:

```
-----  
MC1 - Sartorius      : Balance family and manufacturer  
Model   BP211D      : Balance model  
S/N     040500048   : Serial number of the balance  
ID      : Space for entering the workstation or operator ID  
-----  
Date : 21-Mar-97    : Current date  
Start: 11:00:30    : Time at which the application started  
Ser.  :             : Space for entering a project number  
N     + 5.45390 g   : Measured weights  
N     + 24.34586 g  
N     + 63.23450 g  
End   : 11:15:55   : End of application  
Name  :             : Space for signature of the operator responsible  
-----
```

## Data Printout/Record for Application Programs

For application programs, reference data (parameters) can be included in the printout/record.

To have a data record printed out, perform the following:

– Press **[F]** to output the printout heading and reference data (the reference data will be stored at the same time)

or

– Press **[⊙]** to output the printout heading and the first value

If you input and store new reference values while an ISO/GLP-compliant record is being printed out, the new reference data will be output. If you enter different data before generation of an ISO/GLP record has started, the printout heading and the reference data will automatically be printed once you press **[⊙]**. Then the measured value will be output.

– Press **[⊙]** to output weighing data

– Press **[CF]** to end printout generation (generation of an ISO/GLP printout also ends once an adjustment or calibration operation has been started)

– Then press **[CF]** to clear the reference data for the application programs

The printout can have the following lines:

```
-----  
MC1 – Sartorius      : Balance family and manufacturer  
Model      BP211D    : Balance model  
S/N       040500048  : Serial number of the balance  
ID                                                : Space for entering the workstation or operator ID  
-----  
Date : 21-Mar-97    : Current date  
Start: 14:04:12     : Time at which the application started  
Ser. :              : Space for entering a project number  
nRef +          10 pcs: Reference data (in this case, "counting" –  
                        see also page 45)  
wRef +    0.13400 g  
Qnt  +          500 pcs: Measured values (in this case  
                        "calculated piece count")  
      :  
      :  
End   : 14:13:07    : End of application  
Name  :              : Space for signature of the operator responsible  
-----
```

# Interface Description

## General Information

This description has been written for users who wish to connect their Sartorius balance, which has a built-in V24/V28-RS-232C(-S)\*)/423 interface port as a standard feature, to a computer or a different peripheral device.

By using an on-line computer, you can change, activate and monitor the functions of the balance.

In addition, an external universal switch for remote control of various functions can be connected to the data interface port on the balance.

**If you interface an original Sartorius accessory device, such as a Sartorius Data Printer or a similar unit, with a balance that has the factory-set menu codes, you do not need to change any settings.**

## Interfacing Devices with the Balance

Please note that the interface port is electrically connected to the protective grounding conductor (protective earth = PE) of the balance housing. The cabling supplied as accessory components is shielded and electrically connected on both ends to the cases of the connectors. This electrical connection may result in interference caused by ground loops or by transient currents if you have grounded the housing or connected the protective grounding conductor for AC power. If necessary, connect an equipotential bonding conductor to the balance.

\* ) = Sartorius pin assignment

## General Specifications

Type of interface	Serial point-to-point connector
Operating mode	Asynchronous, full-duplex
Standard	V28, RS-232C specification
Handshake*)	2-wire interface: via software (XON/XOFF) 4-wire interface: via hardware handshake lines with Clear To Send (CTS) and Data Terminal Ready (DTR)
Transmission rates*)	150; 300; 600; 1,200; 2,400; 4,800; 9,600; 19,200 baud
Character coding	7-bit ASCII
Parity*)	Mark, space, odd, even
Synchronization	1 start bit; 1 or 2 stop bits*)
Data output format*) of the balance	16 or 22 characters
Character format*)	– 1 start bit – 7-bit ASCII – 1 parity bit – 1 or 2 stop bits

\*) = can be changed by the user

# Data Output Formats

Depending on the menu code setting:

7 2 1 = without data ID code

or 7 2 2 = with data ID code

data will be output with either 16 (code 7 2 1) or 22 characters (code 7 2 2).

For data output of 22 characters, a 6-character ID precedes the 16 characters reserved for the weight or other value.

## Data Output Format with 16 Characters

Display segments that are not activated ("+" or "-" sign, leading zeros other than zeros before the decimal point) are output as spaces.

The following data block format is output according to what is displayed on the balance:

1	2	3	4	5	6	7	8	9	10	11	12	13	14	15	16
+		*	*	*	*	*	*								
		10 <sup>6</sup>	10 <sup>5</sup>	10 <sup>4</sup>	10 <sup>3</sup>	10 <sup>2</sup>	10 <sup>1</sup>	10 <sup>0</sup>			*	*	*		
		0	0	0	0	0	0	0							
*	*									*				CR	LF
			.	.	.	.	.	.	.						
											U	U	U		
-				10 <sup>5</sup>	10 <sup>4</sup>	10 <sup>3</sup>	10 <sup>2</sup>	10 <sup>1</sup>	10 <sup>0</sup>						
				0	0	0	0	0	0						
				*	*	*	*	*	*						

\* = space; U = unit



When data are output without decimals, the decimal point is suppressed (except when a certain display mode is selected).

1	2	3	4	5	6	7	8	9	10	11	12	13	14	15	16
+			*	*	*	*	*	*							
*	*	*	10 <sup>6</sup>	10 <sup>5</sup>	10 <sup>4</sup>	10 <sup>3</sup>	10 <sup>2</sup>	10 <sup>1</sup>	10 <sup>0</sup>	*	*	*	*	CR	LF
-				0	0	0	0	0	0		U	U	U		

Data output example: +72.55 g

1	2	3	4	5	6	7	8	9	10	11	12	13	14	15	16
+	*	*	*	*	7	2	.	5	5	*	g	*	*	CR	LF

Characters:

1st	Plus or minus sign or space
2nd	Space
3rd–10th	Weight with a decimal point, leading zeros = space
11th	Space
12th–14th	Unit symbol or space
15th	Carriage return (CR)
16th	Line feed (LF)

If the weighing system has not stabilized, no unit symbol will be output.

Unit symbols:

* * *	No stability parameter	GN *	Grains
o * *	Taiwanese tael (o)	d w t	Pennyweights
g * *	Grams	m g *	Milligrams
k g *	Kilograms	/ l b	Parts per pound
c t *	Carats	t l c	Chinese tael
l b *	Pounds	m o m	Mommes
o z *	Ounces	K * *	Austrian carats
o z t	Troy ounces	t o l	Tola
t l h	Hong Kong tael	b a t	Baht
t l s	Singapore tael	MS *	Mesghal
t l t	Taiwanese tael		

\* = space; U = unit

## Special Codes

Special codes are output only if the balance operating menu code 611, 614 or 615 is set (see the section entitled "Data Output Parameters").

Special status-dependent codes

1	2	3	4	5	6	7	8	9	10	11	12	13	14	15	16
*	*	*	*	*	*	A	B	*	*	*	*	*	*	CR	LF

The following status codes are output for "A B":

* *	: Tare	H *	: Overload
C *	: Calibrate*)	L *	: Underload
- -	: All numerals indicated in stable readout		

Special error-dependent codes

1	2	3	4	5	6	7	8	9	10	11	12	13	14	15	16
*	*	*	E	R	R	*	X	Y	Z	*	*	*	*	CR	LF

X = \*, 0, 1 or 2 as a one-place error code

Y Z = two-place error index code

\* = space

\*) = The displayed status code "C" will also be output when a print command is received and if the balance has a built-in calibration weight

### Data Output with ID Code

When data with an ID code are output, the ID code consisting of 6 characters precedes the data with the 16-character format.

During data output, all characters are shifted to the right by 6 places.

1st						7th														22nd character	
C	C	C	C	C	C	S	*	x	x	x	x	x	x	x	x	*	U	U	U	CR	LF
*	*	*	*	*	*	*	*	*	.	.	.	.	.	.	.	*	*	*	*	*	*

- S = Plus or minus sign
- \* = Space
- x = Digit
- U = Unit
- . = Decimal point
- C = Letter for an ID comment
- CR = Carriage return
- LF = Line feed

When special codes are output, the letters "Stat" for status code are assigned to the 1st through the 4th characters of the data string.

Status-dependent string:

1st						7th						13th	14th							22nd character		
S	t	a	t	*	*	*	*	*	*	*	*	A	B	*	*	*	*	*	*	*	CR	LF

A, B = status codes

Error-dependent string:

1st						7th		10 - 12th		14 - 16th											22nd character		
S	t	a	t	*	*	*	*	*	*	*	*	*	*	*	*	*	*	*	*	*	*	CR	LF

# Data Input Formats

Commands can be input via the balance interface port to control the balance functions.

Control commands are distinguished according to those with upper-case letters, or special characters, and those with lower-case letters.

## Format for Control Commands

Control commands can include up to 13 characters.

Each character must be transmitted with a start bit, a 7-bit ASCII-coded character, a parity bit and one or two stop bits.

You can define the parity, baud rate, handshake mode and the number of stop bits by programming the respective codes in the balance operating menu (see page 35).

Formats:

ESC	K	CR	LF
-----	---	----	----

ESC	f	X	_	CR	LF
-----	---	---	---	----	----

ESC = Escape (ASCII 27)

K, f = Command characters (see following pages)

X = Number

\_ = Underline (ASCII 95)

CR = Carriage return (ASCII 13)

LF = Line feed (ASCII 10)

The characters CR and LF do not have to be transmitted in the data string.

## Control Commands with Upper-Case Letters or Special Characters

ESC	P	CR	LF
-----	---	----	----

 (print; activate/block auto print)

ESC	S	CR	LF
-----	---	----	----

    Restart/self-test

ESC	T	CR	LF
-----	---	----	----

    Tare

ESC	Z	CR	LF
-----	---	----	----

    Internal calibration (adjustment)\*

The "P," "T" and "Z" commands do not affect the menu code settings of the balance to reinitialize (turns the scale off and back on again). The "S" command causes the processor to reinitialize (turns the scale off and back on again).

The balance will operate according to the commands available up until the processor is reinitialized. Once the balance has been turned on, the processor will always recognize the codes entered by the user in the balance operating menu.

ESC	O	CR	LF
-----	---	----	----

    Block the keys

ESC	R	CR	LF
-----	---	----	----

    Release the keys

### Important Note

The  key is not blocked!

## Adaptation to Ambient Conditions

ESC	K	CR	LF
-----	---	----	----

    Very stable

ESC	L	CR	LF
-----	---	----	----

    Stable

ESC	M	CR	LF
-----	---	----	----

    Unstable

ESC	N	CR	LF
-----	---	----	----

    Very unstable

\* = only for balances with a built-in automatic calibration weight

## Control Commands with Lower-Case Letters

All functions that can be selected by pressing the respective keys on the balance can also be activated by commands.

ESC	f	0	_	CR	LF	<u>F</u>	function key
ESC	f	1	_	CR	LF	<u>CAL</u>	function key
ESC	s	3	_	CR	LF	<u>CF</u>	clear function
ESC	x	0	_	CR	LF		Perform calibration test*
ESC	x	1	_	CR	LF		Output scale model
ESC	x	2	_	CR	LF		Output serial number

Each control command with the lower-case letters "f," "s" and "x" must be terminated by an underline (ASCII = 95).

\* = only for balances with a built-in automatic calibration weight

# Synchronization and Data Output Parameters

## Definition

During data communication between the balance and an on-line device (computer), "telegram-style" information consisting of ASCII characters is transmitted by the interface.

For error-free data communication, the interface parameters, including the baud rate, parity and handshake mode as well as the character format, must be the same for both units.

You can change these parameters in the balance operating menu so that they match those of the on-line device.

In addition to these parameter settings, you can define the data output parameter of the balance so that data are transmitted depending on various conditions – see "Utilities..." on page 36.

If you do not plug a peripheral device into the interface port on the balance, this will not generate an error code. In this case, data will be output but not received.

## Handshake

The balance interface (Sartorius Balance Interface = SBI) has a 23-byte transmit buffer and a 40-byte receive buffer.

You can access the balance operating menu to define various handshake parameters:

Software handshake: – controlled by "XOFF" and "XON"

Hardware handshake: – after "CTS" send 2 characters

– after "CTS" send 1 character

## What happens when you define a software handshake?

Receiving device:

"XOFF" will not be transmitted until the receive buffer has stored the 26th character. The enable command "XON" is given after the buffer has transmitted all characters up to the 14th character.

If the device addressed does not understand the control command, the receiving device continues to operate additionally with a hardware handshake after it has received another 6 characters.

For data communication with a software handshake, "XON" must be sent by a device when it is turned on in order to enable another on-line device to exchange data.

Sequence:

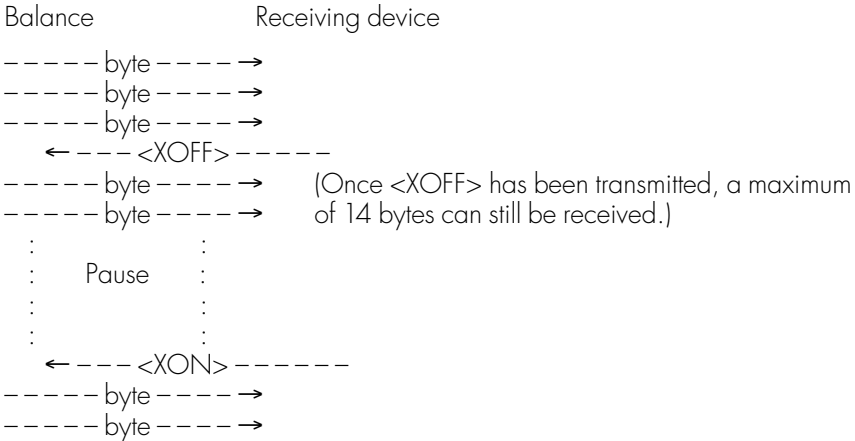

Transmitting device:

The importance of handshake control for data transmission becomes especially apparent

- when the continuous automatic data output parameter is defined
- when data output is controlled by application programs

Once <XOFF> has been received, it prevents further transmission of characters.

When <XON> is received, it re-enables the transmitting device to send data.

The transmitting device is always enabled for sending data after it has been switched on.

If data transmission is interrupted by the control line (CTS) or the command <XOFF> while a data block is being output from an application program (only for printing a section of text with several lines of data), the readout will be locked into the display at the same time.

Data output will be blocked until the interface receives an enabling signal.



## Activating a Data Output Process

You can define the data output parameter so that output is activated either automatically or when a print command is received. You have two options for the automatic mode: data output can be either synchronous with the balance display or activated at defined intervals (to select the parameter, see the section entitled "Utilities for Printouts or Data Transfer").

### Data Output by Print Command

The print command can be transmitted by a software command or by pressing .

In addition to an interface cable for a different device, you can connect an external universal switch for remote control to the balance interface port (for the print function, see page 35). For the switch, use pins 8 and 15 of this port and a cable up to 1.5 m or 5 ft. long (RS-232C).

If data output is requested by a software command (see the section on "Data Input Formats"), you can install a 15-m (50-ft.) cable for RS-232C.

### Automatic Data Output

In the "auto print" operating mode, the data are output to the interface port without requiring a print command. You can choose to have data output automatically at defined print intervals with or without the stability parameter. Whichever parameter you select, the data will be output as the readouts appear on the balance display. If you select the auto print setting, data will be transmitted immediately the moment you turn on the balance. This data output function is described under "Utilities..." on page 36.

### Higher Data Output Rates

If you require an output rate higher than 10 Hz, ask Sartorius for this information.

# Pin Assignment Chart

## Female Interface Connector:

25-position D-submini, DB25S, with screw lock hardware for cable gland

## Male Connector Used:

(please use connectors with the same specifications)  
25-pin D-submini, DB25S, with integrated shielded cable clamp assembly  
(Amp type 826 985-1C) and fastening screws (Amp type 164 868-1)



## Warning When Using Pre-wired RS-232 Connecting Cables!

RS-232 cables purchased from other manufacturers often have incorrect pin assignments for use with Sartorius balances. Be sure to check the pin assignment against the chart below before connecting the cable, and disconnect any lines marked "Internally Connected" (e.g., pin 6). Failure to do so may damage or even completely ruin your balance and/or peripheral device.

## Pin Assignment:

- Pin 1: Signal Ground
- Pin 2: Data Output (TxD)
- Pin 3: Data Input (RxD)
- Pin 4: Internal Ground (GND)
- Pin 5: Clear to Send (CTS)
- Pin 6: Internally Connected
- Pin 7: Internal Ground (GND)
- Pin 8: Internal Ground (GND)
- Pin 9: Reset \_ In\*)
- Pin 10: Not Connected
- Pin 11: +12 V
- Pin 12: Reset \_ Out\*)
- Pin 13: +5 V
- Pin 14: Internal Ground (GND)
- Pin 15: Universal Switch
- Pin 16: Not Connected
- Pin 17: Not Connected
- Pin 18: Not Connected
- Pin 19: Not Connected
- Pin 20: Data Terminal Ready (DTR)
- Pin 21: Internal Ground (GND)
- Pin 22: Not Connected
- Pin 23: Not Connected
- Pin 24: Not Connected
- Pin 25: +5 V

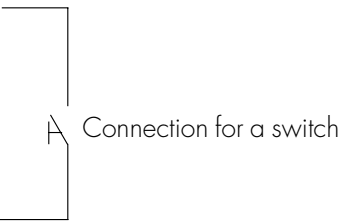

\*) = hardware restart

# Cabling Diagram

Diagram for interfacing a computer or a different peripheral device to the balance using the RS-232C/V24 standard and interface cables up to 15 m (50 ft.) long.

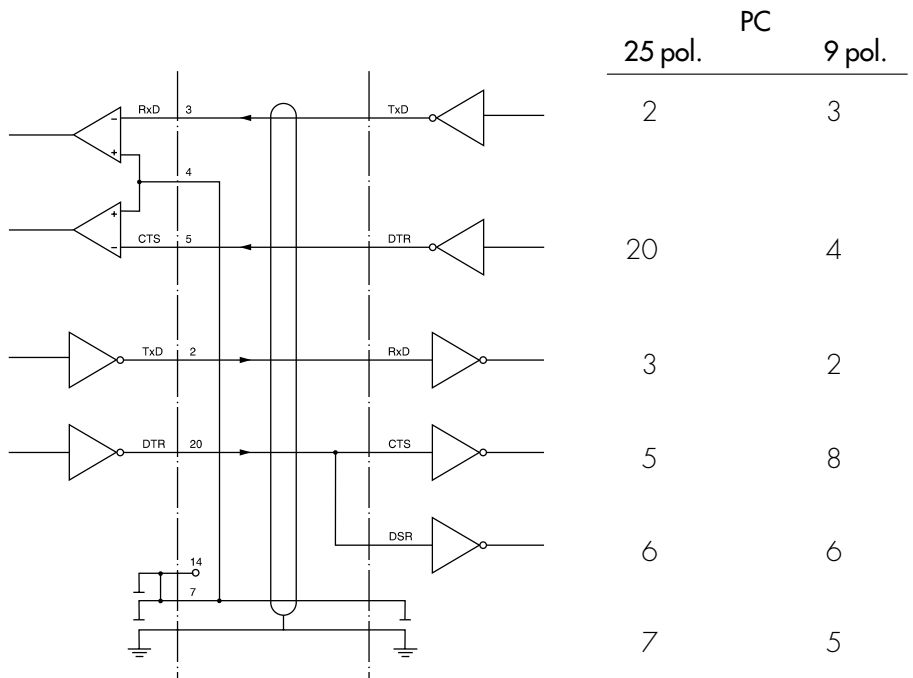
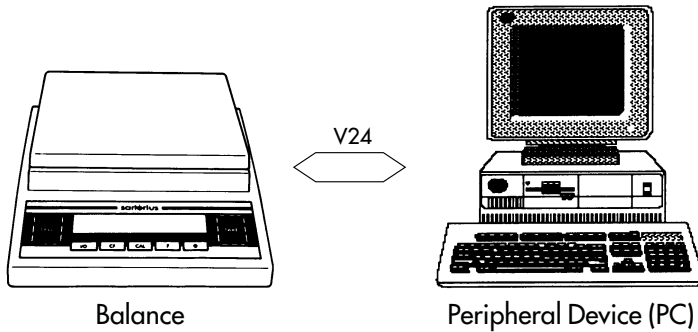

Type of cable: AWG 24 specification

# Specifications

## Basicplus

Model		BP 211 D	BP 301 S
Weighing range structure		DualRange	SuperRange
Weighing capacity	g	40/80/210	303
Readability	mg	0.01/0.01/0.1	0.1
Tare range (by subtraction)	mg	-210	-303
Reproducibility (standard deviation)*	mg	≤0.02/≤0.05/≤0.1	≤0.2
Linearity	mg	≤±0.03/≤±0.1/≤±0.2	≤±0.3
Response time (average)	s	≤12/3	≤3
Allowable ambient operating temperature	°C	+5 ... +40	
Operating temperature range	°C	+10 ... +30	
Sensitivity drift within +10 °C ... +30 °C	/°C	≤±1 · 10 <sup>-6</sup>	
Pan size	mm	Ø 80	
Weighing chamber height (effect. dimens.)	mm	225	
Dimensions (WxDxH)			
– Balance	mm	204x297x332	204x297x332
– Electronics box	mm	134x51x155	–
Net weight, approx.	kg	6.6	5.5
External calibration weight (of at least accuracy class...)	g	200 (E2)	200+100 (E2)
Power requirements	V~	Via AC adapter: STNG 6/TNG 6, 230 VAC or 115 VAC, -20% ... +15% (IP 20 protection)	
Frequency	Hz	48–63	
Power consumption (average)	VA	16 maximum; 8 average	
Hours of operation with fully charged YRB 05 Z external battery pack, approx.	h	25	32
Built-in interface		RS-232C-S/V24-V28; 7-bit; parity: even, mark, odd, space; transmission rates: 150 ... 19,200 baud; 1 or 2 stop bits; software/hardware handshake	

### Standard features/equipment supplied:

Dust cover	x	x
AC adapter, varies acc. to country	x	x
Built-in calibration weight	x	x
Level indicator	x	x
Hanger for below-balance weighing	x	x

\* = standard deviation of the reproducibility acc. to DIN 8120, Part 3

Model		BP 221 S	BP 161 P	BP 121 S	BP 61 S
Weighing range structure		SuperRange	PolyRange	SuperRange	SuperRange
Weighing capacity	g	220	30/60/ 110/160	120	61
Readability	g	0.0001	0.0001/ 0.0002/ 0.0005/ 0.001	0.0001	0.0001
Tare range (by subtraction)	g	-220	-160	-120	-61
Reproducibility (standard deviation)*	g	≤±0.0001	≤±0.0001/ 0.0002/ 0.0005/ 0.001	≤±0.0001	≤±0.0001
Linearity	g	≤±0.0002	≤±0.0002/ 0.0002/ 0.0005/ 0.001	≤±0.0002	≤±0.0002
Response time (average)	s	≤2			
Allowable ambient operating temperature	°C	+5 ... +40			
Operating temperature range	°C	+10 ... +30			
Sensitivity drift within +10 °C ... +30 °C	/°C	≤± 1 · 10 <sup>-6</sup>			
Pan size	mm	Ø 80			
Weighing chamber height	mm	225			
Dimensions (WxDxH)	mm	204x297x332			
Net weight, approx.	kg	5.4			
External calibration weight (of at least accuracy class...)	g	200 (E2)	100 (E2)	100 (E2)	50 (E2)
Power requirements	V~	Via AC adapter: STNG 6, 230 VAC or 115 VAC, -20% ... +15% (IP 20 protection)			
Frequency	Hz	48-63			
Power consumption (average)	VA	16 maximum; 8 average			
Hours of operation with fully charged YRB 05 Z external battery pack, approx.:	h	32			
Built-in interface		RS-232C-S/V24-V28; 7-bit; parity: even, mark, odd, space; transmission rates: 150...19,200 baud; 1 or 2 stop bits; software/hardware handshake			
<b>Standard features/equipment supplied:</b>					
Analytical draft shield		x	x	x	x
Dust cover		x	x	x	x
AC adapter, varies acc. to country		x	x	x	x
Built-in calibration weight		x	x	x	x
Level indicator		x	x	x	x
Hanger for below-balance weighing		x	x	x	x

\* = standard deviation of the reproducibility acc. to DIN 8120, Part 3

Model		BP 410 S	BP 310 S	BP 310 P	BP 150
Weighing range structure		SuperRange	SuperRange	PolyRange	
Weighing capacity	g	410	310	60/120/310	150
Readability	g	0.001	0.001	0.001/0.002/ 0.005	0.001
Tare range (by subtraction)	g	-410	-310	-310	-150
Reproducibility (standard deviation)*	g	≤±0.001	≤±0.001	≤±0.001/ 0.001/ 0.003	≤±0.001
Linearity	g	≤±0.002	≤±0.002	≤±0.002/ 0.002/ 0.005	≤±0.001
Response time (average)	s	≤ 1.5			
Allowable ambient operating temperature	°C	0 ... +40			
Operating temperature range	°C	+10 ... +30			
Sensitivity drift within +10 °C ... +30 °C	/°C	≤± 2 · 10 <sup>-6</sup>			
Pan size	mm	Ø 115			
Dimensions (WxDxH)	mm	204 x 130 x 297			
Net weight, approx.	kg	3.1			
External calibration weight (of at least accuracy class ...)	g	200 (F1)	200 (F1)	100 (F1)	100 (F1)
Power requirements	V~	Via AC adapter: STNG 6, 230 VAC or 115 VAC, -20% ... +15% (IP 20 protection)			
Frequency	Hz	48-63			
Power consumption (average)	VA	16 maximum; 8 average			
Hours of operation with fully charged YRB 05 Z external battery pack, approx.	h	25			
Built-in interface		RS-232C-S/V24-V28; 7-bit; parity: even, mark, odd, space; transmission rates: 150...19,200 baud; 1 or 2 stop bits; software/hardware handshake			

#### Standard features/equipment supplied:

Round glass draft shield	x	x	x
AC adapter, varies acc. to country	x	x	x
Level indicator	x	x	x
Hanger for below-balance weighing	x	x	x

\* = standard deviation of the reproducibility acc. to DIN 8120, Part 3

Model		BP 610	BP 410
Weighing capacity	g	610	410
Readability	g	0.01	0.01
Tare range (by subtraction)	g	-610	-410
Reproducibility (standard deviation)*	g	≤±0.01	≤±0.01
Linearity	g	≤±0.01	≤±0.01
Response time (average)	s	≤ 1	
Allowable ambient operating temperature	°C	0 ... +40	
Operating temperature range	°C	+10 ... +30	
Sensitivity drift within +10 °C ... +30 °C	/°C	≤± 5 · 10 <sup>-6</sup>	
Pan size	mm	Ø 115	
Dimensions (WxDxH)	mm	204x297x80	
Net weight, approx.	kg	1.9	
External calibration weight (of at least accuracy class...)	g	500 (F2)	200 (F2)
Power requirements	V~	Via AC adapter: STNG 6, 230 VAC or 115 VAC, -20% ... +15% (IP 20 protection)	
Frequency	Hz	48-63	
Power consumption (average)	VA	16 maximum; 8 average	
Hours of operation with fully charged YRB 05 Z external battery pack, approx.	h	45	
Built-in interface		RS-232C-S/V24-V28; 7-bit; parity: even, mark, odd, space; transmission rates: 150...19,200 baud; 1 or 2 stop bits; software/hardware handshake	
<b>Standard features/equipment supplied:</b>			
AC adapter, varies acc. to country		x	x
Level indicator		x	x
Hanger for below-balance weighing		x	x

\* = standard deviation of the reproducibility acc. to DIN 8120, Part 3

Model	BP 4100 S	BP 3100 S	BP 3100 P
Weighing range structure	SuperRange	SuperRange	PolyRange
Weighing capacity	g 4,100	3,100	600/1,200/ 3,100
Readability	g 0.01	0.01	0.01/0.02/ 0.05
Tare range (by subtraction)	g -4,100	-3,100	-3,100
Reproducibility (standard deviation)*	g $\leq \pm 0.01$	$\leq \pm 0.01$	$\leq \pm 0.01$ / 0.01/0.03
Linearity	g $\leq \pm 0.02$	$\leq \pm 0.02$	$\leq \pm 0.02$ / 0.02/0.05
Response time (average)	s $\leq 1.5$		
Allowable ambient operating temperature	°C 0 ... +40		
Operating temperature range	°C +10 ... +30		
Sensitivity drift within +10 °C ... +30 °C	/°C $\leq \pm 2 \cdot 10^{-6}$		
Pan size	mm 180 x 180		
Dimensions (WxDxH)	mm 204x297x81		
Net weight, approx.	kg 3.1		
External calibration weight (of at least accuracy class...)	g 2,000 (F1)	2,000 (F1)	1,000 (F1)
Power requirements	V~	Via AC adapter: STNG 6, 230 VAC or 115 VAC, -20% ... +15% (IP 20 protection)	
Frequency	Hz 48-63		
Power consumption (average)	VA 16 maximum; 8 average		
Hours of operation with fully charged YRB 05 Z external battery pack, approx.	h 25		
Built-in interface	RS-232C-S/V24-V28; 7-bit; parity: even, mark, odd, space; transmission rates: 150...19,200 baud; 1 or 2 stop bits; software/hardware handshake		
<b>Standard features/equipment supplied:</b>			
AC adapter, varies acc. to country	x	x	x
Level indicator	x	x	x
Hanger for below-balance weighing	x	x	x

\* = standard deviation of the reproducibility acc. to DIN 8120, Part 3



Model		BP 2100 S	BP 1200
Weighing range structure		SuperRange	
Weighing capacity	g	2,100	1,200
Readability	g	0.01	0.01
Tare range (by subtraction)	g	-2,100	-1,200
Reproducibility (standard deviation)*	g	≤±0.01	≤±0.01
Linearity	g	≤±0.02	≤±0.02
Response time (average)	s	≤ 1.5	
Allowable ambient operating temperature	°C	0 ... +40	
Operating temperature range	°C	+10 ... +30	
Sensitivity drift within +10 °C ... +30 °C	/°C	≤± 2 · 10 <sup>-6</sup>	
Pan size	mm	180 x 180	
Dimensions (WxDxH)	mm	204x297x81	
Net weight, approx.	kg	3.1	
External calibration weight (of at least accuracy class...)	g	1,000 (F1)	1,000 (F1)
Power requirements	V~	Via AC adapter: STING 6, 230 VAC or 115 VAC, -20% ... +15% (IP 20 protection)	
Frequency	Hz	48-63	
Power consumption (average)	VA	16 maximum; 8 average	
Hours of operation with fully charged YRB 05 Z external battery pack, approx.	h	25	
Built-in interface		RS-232C-S/V24-V28; 7-bit; parity: even, mark, odd, space; transmission rates: 150...19,200 baud; 1 or 2 stop bits; software/hardware handshake	
<b>Standard features/equipment supplied:</b>			
AC adapter, varies acc. to country		x	x
Level indicator		x	x
Hanger for below-balance weighing		x	x

\* = standard deviation of the reproducibility acc. to DIN 8120, Part 3

Model		BP 8100	BP 6100	BP 4100	BP 2100
Weighing capacity	g	8,100	6,100	4,100	2,100
Readability	g	0.1	0.1	0.1	0.1
Tare range (by subtraction)	g	-8,100	-6,100	-4,100	-2,100
Reproducibility (standard deviation)*	g	≤±0.05	≤±0.1	≤±0.1	≤±0.1
Linearity	g	≤±0.1	≤±0.1	≤±0.1	≤±0.1
Response time (average)	s	≤1			
Allowable ambient operating temperature	°C	0... +40			
Operating temperature range	°C	+10... +30			
Sensitivity drift within +10 °C ... +30 °C	/°C	≤±4 · 10 <sup>-6</sup>	≤±5 · 10 <sup>-6</sup>	≤±5 · 10 <sup>-6</sup>	≤±5 · 10 <sup>-6</sup>
Pan size	mm	210 x 180			
Dimensions (WxDxH)	mm	238x297x81			
Net weight, approx.	kg	3.5	3.0	3.0	3.0
External calibration weight (of at least accuracy class...)	g	5,000 (F2)	5,000 (F2)	2,000 (F2)	1,000 (F2)
Power requirements	V~	Via AC adapter: STNG 6, 230 VAC or 115 VAC, -20% ... +15% (IP 20 protection)			
Frequency	Hz	48-63			
Power consumption (average)	VA	16 maximum; 8 average			
Hours of operation with fully charged YRB 05 Z external battery pack, approx.	h	25	45	45	45
Built-in interface		RS-232C-S/V24-V28; 7-bit; parity: even, mark, odd, space; transmission rates: 150...19,200 baud; 1 or 2 stop bits; software/hardware handshake			
<b>Standard features/equipment supplied:</b>					
AC adapter, varies acc. to country		x	x	x	x
Level indicator		x	x	x	x
Hanger for below-balance weighing		x	x	x	x

\* = standard deviation of the reproducibility acc. to DIN 8120, Part 3

Model		BP 16000 S	BP 12000 S	BP 34000 P	BP 34	BP 8
Weighing range structure		SuperRange	SuperRange	PolyRange		
Weighing capacity	kg	16	12	8/16/34	34	8.1
Readability	g	0.1	0.1	0.1/0.2/0.5	1.0	1.0
Tare range (by subtraction)	kg	-16	-12	-34	-34	-8.1
Reproducibility (standard deviation)*	g	≤±0.1	≤±0.1	≤±0.1/0.2/0.5	≤±0.5	≤±0.5
Linearity	g	≤±0.2	≤±0.2	≤±0.3/0.3/0.3	≤±0.5	≤±1
Response time (average)	s	≤1.5	≤1.5	≤1.5	≤1.5	≤1
Allowable ambient operating temperature	°C	0...+40				
Operating temperature range	°C	+10...+30				
Sensitivity drift within +10 °C ... +30 °C	/°C	≤±2 · 10 <sup>-6</sup>	≤±2 · 10 <sup>-6</sup>	≤±2 · 10 <sup>-6</sup>	≤±2 · 10 <sup>-6</sup>	≤±10 · 10 <sup>-6</sup>
Pan size	mm	417 x 307	417 x 307	417 x 307	417 x 307	210 x 180
Dimensions (WxDxH)	mm	307x538x121				
Net weight, approx.	kg	15	15	15	15	3,0
External calibration weight (of at least accuracy class...)	g	10,000 (F1)	10,000 (F1)	10,000 (F2)	10,000 (F2)	5000 (F2)
Power requirements	V~	Via AC adapter: STNG 6, 230 VAC or 115 VAC, -20% ... +15% (IP 20 protection)				
Frequency	Hz	48-63				
Power consumption (average)	VA	8 maximum; 10 average				
Hours of operation with fully charged YRB 06 Z external battery pack, approx.	h	28	28	28	28	25
Built-in interface		RS-232C-S/V24-V28; 7-bit; parity: even, mark, odd, space; transmission rates: 150...19,200 baud; 1 or 2 stop bits; software/hardware handshake				
<b>Standard features/equipment supplied:</b>						
AC adapter, varies acc. to country		x	x	x	x	x
Level indicator		x	x	x	x	x

\* = standard deviation of the reproducibility acc. to DIN 8120, Part 3

# Specifications for Basic<sup>plus</sup> Verified Balances with an EC Type Approval

Model	BP 211 D-OCE	BP 301 S-OCE
Type	BC BC 100	BC BC 100
Accuracy class*	Ⓛ	Ⓛ
Weighing range structure	DualRange	SuperRange
Maximum capacity Max*	g 80/210	303
Scale interval d*	mg 0.01/0.1	0.1
Verification scale interval e*	g 0.001	0.001
Minimum capacity Min*	g 0.001	0.01
Tare range (by subtraction)	g -210	-303
Range of use according to Directive No. 90/384/EEC*	g 0.001-210	0.01-303
Response time (average)	s ≤12/3	≤3
Operating temperature range	°C +15 ... +25	
Pan size	mm Ø 80	
Weighing chamber height (effect. dimens.)	mm 225	
Net weight, approx.	kg 6.6	5.5
Selectable weight units	g, mg	
External calibration weight (of at least accuracy class...)	g 200 [E2]	200 + 100 [E2]
Power requirements	V~ Via AC adapter: STNG 6, 230 VAC or 115 VAC, -20% ... +15% (IP 20 protection)	
Frequency	Hz 48-63	
Power consumption (average)	VA 16 maximum; 8 average	
Hours of operation with fully charged YRB 05 Z external battery pack, approx.	h 25	32
Built-in interface	RS-232C-S/V24-V28; 7-bit; parity: even, odd; transmission rates: 150...19,200 baud; 1 or 2 stop bits; software/hardware handshake	
<b>Standard features/equipment supplied:</b>		
Dust cover	x	x
AC adapter; varies acc. to country	x	x
Built-in, motorized calibration weight	x	x
Level indicator	x	x

\* = EC Directive No. 90/384/EEC for Non-Automatic Weighing Instruments applicable in the EC/EU Member States

Model		BP 221 S-OCE	BP 161 P-OCE	BP 121 S-OCE	BP 61 S-OCE
Type		BC BC 100	BC BC 100	BC BC 100	BC BC 100
Accuracy class		I	I	I	I
Weighing range structure		SuperRange	PolyRange	SuperRange	SuperRange
Maximum capacity Max*	g	220	30/60/ 110/160	120	61
Scale interval d*	mg	0.1	0.1/0.2/ 0.5/1.0	0.1	0.1
Verification scale interval e*	g	0.001	0.001	0.001	0.001
Minimum capacity Min*	g	0.01	0.01	0.01	0.01
Tare range (by subtraction)	g	-220	-160	-120	-61
Range of use according to Directive No. 90/384/EEC*	g	0.01-220	0.01-160	0.01-120	0.01-61
Response time (average)	s	≤ 2			
Allowable ambient operating temperature	°C	+5 ... +40			
Operating temperature range	°C	+15 ... +25			
Pan size	mm	Ø 80			
Weighing chamber height	mm	225			
Dimensions (WxDxH)	mm	204x297x332			
Net weight, approx.	kg	5.4			
Selectable weight units		g, mg			
External calibration weight (of at least accuracy class...)	g	200 (E2)	100 (E2)	100 (E2)	50 (E2)
Power requirements	V~	Via AC adapter: STING 6, 230 VAC or 115 VAC, -20% ... +15% (IP 20 protection)			
Frequency	Hz	48 - 63			
Power consumption (average)	VA	16 maximum; 8 average			
Hours of operation with fully charged YRB 05 Z external battery pack, approx.	h	32			
Built-in interface		RS-232C-S/V24-V28; 7-bit; parity: even, odd; transmission rates: 150...19,200 baud; 1 or 2 stop bits; software/hardware handshake			

#### Standard features/equipment supplied:

Analytical draft shield chamber	x	x	x	x
Dust cover	x	x	x	x
AC adapter; varies acc. to country	x	x	x	x
Built-in, motorized calibration weight	x	x	x	x
Level indicator	x	x	x	x

\* = EC Directive No. 90/384/EEC for Non-Automatic Weighing Instruments applicable in the EC/EU Member States

Model	BP 410 S-OCE	BP 310 S-OCE	BP 310 P-OCE
Type	BD BC 200	BA BC 200, BD BC 200	BA BC 200, BD BC 200
Accuracy class	Ⓜ	Ⓜ	Ⓜ
Weighing range structure	SuperRange	SuperRange	PolyRange
Maximum capacity Max*	g 410	310	60/120/310
Scale interval d*	g 0.001	0.001	0.001/ 0.002/0.005
Verification scale interval e*	g 0.01	0.01	0.01
Minimum capacity Min*	g 0.02	0.02	0.02
Tare range (by subtraction)	g -410	-310	-310
Range of use according to Directive No. 90/384/EEC*	g 0.02-410	0.02-310	0.02-310
Response time (average)	s ≤1.5		
Allowable ambient operating temperature	°C 0...+40		
Operating temperature range	°C +10...+30		
Pan size	mm Ø 115		
Dimensions (WxDxH)	mm 204x297x 130		
Net weight, approx.	kg 3.1		
Selectable weight units	g, kg		
Power requirements	V~	Via AC adapter: STNG 6, 230 VAC or 115 VAC, -20% ... +15% (IP 20 protection)	
Frequency	Hz 48-63		
Power consumption (average)	VA 16 maximum; 8 average		
Hours of operation with fully charged YRB 05 Z external battery pack, approx.	h 25		
Built-in interface	RS-232C-S/V24-V28; 7-bit; parity: even, odd; transmission rates: 150...19,200 baud; 1 or 2 stop bits; software/hardware handshake		
<b>Standard features/equipment supplied:</b>			
Round glass draft shield	x	x	x
AC adapter; varies acc. to country	x	x	x
Built-in, motorized calibration weight	x	x	x
Level indicator	x	x	x

\* = EC Directive No. 90/384/EEC for Non-Automatic Weighing Instruments applicable in the EC/EU Member States

Model		BP 150-OCE	BP 110-OCE	BP 610-OCE
Type		BD BC 200	BA BC 200, BD BC 200	BA BC 200, BD BC 200
Accuracy class		Ⓜ	Ⓜ	Ⓜ
Weighing range structure		SuperRange	SuperRange	PolyRange
Maximum capacity Max*	g	150	110	610
Scale interval d*	g	0.001	0.001	0.01
Verification scale interval e*	g	0.01	0.01	0.1
Minimum capacity Min*	g	0.02	0.02	0.5
Tare range (by subtraction)	g	-150	-110	-610
Range of use according to Directive No. 90/384/EEC*	g	0.02-410	0.02-110	0.5-610
Response time (average)	s	≤ 1.5		
Allowable ambient operating temperature	°C	0...+40		
Operating temperature range	°C	+10...+30		
Pan size	mm	Ø 115		
Dimensions (WxDxH)	mm	204x297x130		
Net weight, approx.	kg	3.1		
Selectable weight units		g, kg		
Power requirements	V~	Via AC adapter: STNG 6, 230 VAC or 115 VAC, -20% ... +15% (IP 20 protection)		
Frequency	Hz	48-63		
Power consumption (average)	VA	16 maximum; 8 average		
Hours of operation with fully charged YRB 05 Z external battery pack, approx.	h	25		
Built-in interface		RS-232C-S/V24-V28; 7-bit; parity: even, odd; transmission rates: 150...19,200 baud; 1 or 2 stop bits; software/hardware handshake		
<b>Standard features/equipment supplied:</b>				
Round glass draft shield		x	x	x
AC adapter; varies acc. to country		x	x	x
Built-in, motorized calibration weight		x	x	x
Level indicator		x	x	x

\* = EC Directive No. 90/384/EEC for Non-Automatic Weighing Instruments applicable in the EC/EU Member States

Model	BP 4100 S-OCE	BP 3100 S-OCE	BP 3100 P-OCE
Type	BD BC 200	BA BC 200, BD BC 200	BA BC 200, BD BC 200
Accuracy class	Ⓜ	Ⓜ	Ⓜ
Weighing range structure	SuperRange	SuperRange	PolyRange
Maximum capacity Max*	g 4,100	3,100	600/1,200/ 3,100
Scale interval d*	g 0.01	0.01	0.01/0.02/ 0.05
Verification scale interval e*	g	0.10.1	0.1
Minimum capacity Min*	g 0.5	0.5	0.5
Tare range (by subtraction)	g -4,100	-3,100	-3,100
Range of use according to Directive No. 90/384/EEC*	g 0.5-4,100	0.5-3,100	0.5-3,100
Response time (average)	s ≤1.5		
Allowable ambient operating temperature	°C 0...+40		
Operating temperature range	°C +10...+30		
Pan size	mm 180 x 180		
Dimensions (WxDxH)	mm 204x297x81		
Net weight, approx.	kg 3.2		
Selectable weight units	g, kg		
Power requirements	V~	Via AC adapter: STNG 6, 230 VAC or 115 VAC, -20% ... +15% (IP 20 protection)	
Frequency	Hz 48-63		
Power consumption (average)	VA 16 maximum; 8 average		
Hours of operation with fully charged YRB 05 Z external battery pack, approx.	h 2.5		
Built-in interface	RS-232C-S/V24-V28; 7-bit; parity: even, odd; transmission rates: 150...19,200 baud; 1 or 2 stop bits; software/hardware handshake		

#### Standard features/equipment supplied:

Pan Shield	x	-	-
AC adapter; varies acc. to country	x	x	x
Built-in, motorized calibration weight	x	x	x
Level indicator	x	x	x

\* = EC Directive No. 90/384/EEC for Non-Automatic Weighing Instruments applicable in the EC/EU Member States



Model		BP 2100 S-OCE	BP 1200-OCE
Type		BA BC 200, BD BC 200	BA BC 200, BD BC 200
Accuracy class		Ⓜ	Ⓜ
Weighing range structure		SuperRange	
Maximum capacity Max* 3,100	g	2,100	1,200
Scale interval d* 0,05	g	0.01	0.01
Verification scale interval e*	g	0.1	0.1
Minimum capacity Min*	g	0.5	0.5
Tare range (by subtraction)	g	-2,100	-1,200
Range of use according to Directive No. 90/384/EEC*	g	0.5-2,100	0.5-1,200
Response time (average)	s	≤1.5	
Allowable ambient operating temperature	°C	0...+40	
Operating temperature range	°C	+10...+30	
Pan size	mm	180 x 180	
Dimensions (WxDxH)	mm	204x297x81	
Net weight, approx.	kg	3.2	
Selectable weight units		g, kg	
Power requirements	V~	Via AC adapter: STNG 6, 230 VAC or 115 VAC, -20%...+15% (IP 20 protection)	
Frequency	Hz	48-63	
Power consumption (average)	VA	16 maximum; 8 average	
Hours of operation with fully charged YRB 05 Z external battery pack, approx.	h	25	
Built-in interface		RS-232C-S/V24-V28; 7-bit; parity: even, odd; transmission rates: 150...19,200 baud; 1 or 2 stop bits; software/hardware handshake	
<b>Standard features/equipment supplied:</b>			
AC adapter; varies acc. to country		x	x
Built-in, motorized calibration weight		x	x
Level indicator		x	x

\* = EC Directive No. 90/384/EEC for Non-Automatic Weighing Instruments applicable in the EC/EU Member States

Model		BP 8100-OCE	BP 6100-OCE	BP 2100-OCE	BP 8-OCE
Type		BA BC 200, BD BC 200	BA BC 200, BD BC 200	BA BC 200, BD BC 200	BA BC 200, BD BC 200
Accuracy class		II	II	II	II
Maximum capacity Max*	g	8,100	6,100	2,100	8,100
Scale interval d*	g	0.1	0.1	0.1	1.0
Verification scale interval e*	g	1.0	1.0	0.1	1.0
Minimum capacity Min*	g	5.0	5.0	5.0	50
Tare range (by subtraction)	g	-8,100	-6,100	-2,100	-8,100
Range of use according to Directive No. 90/384/EEC*	g	5-8,100	5-6,100	5-2,100	50-8,100
Response time (average)	s	≤1	≤1	≤1	≤1
Allowable ambient operating temperature	°C	0...+40			
Operating temperature range	°C	+10...+30			
Pan size	mm	210 x 180	210 x 180	180 x 180	210 x 180
Dimensions (WxDxH)	mm	238 x 297 x 81			
Net weight, approx.	kg	4.9			
Selectable weight units		g, kg			
Power requirements	V~	Via AC adapter: STNG 6, 230 VAC or 115 VAC, -20% ... +15% (IP 20 protection)			
Frequency	Hz	48-63			
Power consumption (average)	VA	16 maximum; 8 average			
Hours of operation with fully charged YRB 05 Z external battery pack, approx.	h	25	25	25	25
Built-in interface		RS-232C-S/V24-V28; 7-bit; parity: even, odd; transmission rates: 150...19,200 baud; 1 or 2 stop bits; software/hardware handshake			
<b>Standard features/equipment supplied:</b>					
AC adapter; varies acc. to country		x	x	x	x
Built-in, motorized calibration weight		x	x	x	x
Level indicator		x	x	x	x

\* = EC Directive No. 90/384/EEC for Non-Automatic Weighing Instruments applicable in the EC/EU Member States

# Physikalisch-Technische Bundesanstalt

Braunschweig und Berlin

**EG-Bauartzulassung  
Zulassungsschein**



**EC Type approval  
certificate**

**Nr. D95-09-011      2. Revision**

ausgestellt von  
*issued by*                      Physikalisch-Technische Bundesanstalt  
   Bundesallee 100  
   D - 38116 Braunschweig  
   Bundesrepublik Deutschland

benannte Stelle  
*notified body*                      0102

gemäß  
*in accordance with*              § 13 des Eichgesetzes (verification act) vom 23. März 1992 (BGBl. I S.711)  
   und § 7c (2) Eichordnung (verification ordinance) in der Fassung vom (version  
   of) 21. Juni 1994 (BGBl. I S. 1293), entsprechend der Richtlinie (implementing  
   council directive) 90/384/EWG, geändert durch (amended by) 93/68/EWG

ausgestellt für  
*issued to*                              Sartorius AG  
   Weender Landstraße 94-108  
   37075 Göttingen  
   Bundesrepublik Deutschland

für  
*in respect of*                      **Nichtselbsttätige elektromechanische Waage**  
   **Nonautomatic electromechanical weighing instrument**

Typ  
*type*                                      **KA BC 100, MB BC 100, BC BC 100, BA BC 200, BD BC 200, MA BC 200, und  
MD BC 200**

   (I)                      Max 50...310 g,      e = 1...5 mg      n ≤ 310000

   (II)                      Max 50...12000 g,      e = 0,01...1 g      n ≤ 42000

gültig bis  
*valid until*                              05.04.2005

Die Hauptmerkmale, Zulassungsbedingungen und Auflagen sind in der Anlage enthalten, die Bestandteil der Zulassung ist und 6 Seiten umfaßt.

*The principal characteristics, approval conditions and special conditions if any are set out in the Appendix hereto, which forms part of the approval document and comprises 6 pages.*

Diese 2. Revision ersetzt den Zulassungsschein Nr. D95-09-011, 1. Revision, vom 08.09.1997 mit Anlage.

*This 2nd Revision replaces the EC Type approval certificate No. D95-09-011, 1st Revision, dated 08.09.1997 with Appendix.*

Braunschweig,                      26.10.1998  
Geschäftszeichen:                      1.14-98049520  
Reference No:

Im Auftrag  
By order

*Baars*  
Baars



Hinweise und Rechtsbehelfsbelehrung auf der Rückseite. Zulassungsscheine ohne Unterschrift und ohne Dienststempel haben keine Gültigkeit. Dieser Zulassungsschein darf nur unverändert weiterverbreitet werden. Auszüge oder Änderungen bedürfen der Genehmigung der Physikalisch-Technischen Bundesanstalt.

*Further information and legal remedy instruction see over-leaf. Type approval certificates are valid only with signature and seal. This type approval certificate shall be reproduced only in full. Partial reproduction or modification only upon permission of the Physikalisch-Technische Bundesanstalt.*

## Accessories (Options)

Product

Order No.

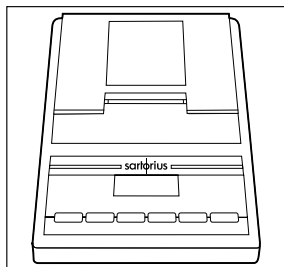

### Data printer

with date/time, statistical evaluation data, transaction counter functions and LCD

YDP 03-OCE

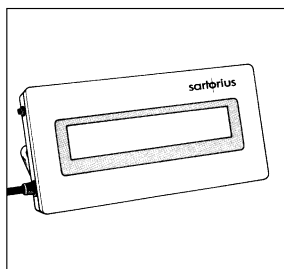

### Remote display

(can be connected via the interface port)

- LCD, reflective
- LCD, for overhead projectors, transmissive

YRD 12 Z

YRD 13 Z

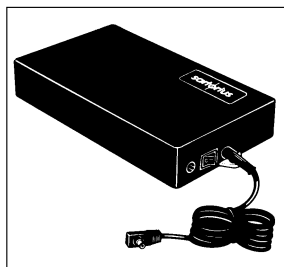

### External rechargeable battery pack

- for balances with a weighing capacity of <math>< 10\text{ kg}</math>
- for balances with a weighing capacity of  $\geq 10\text{ kg}$

YRB 05 Z

YRB 06 Z

has a battery-level indicator (LED); can be recharged using the AC adapter (time it takes to charge the discharged battery pack: 15 hours); see "Specifications" for hours of operation

### External calibration weights:

For Models	Accuracy Class (OIML)	Weight in g	Order No.
BP 61 S	E2	1x50	<b>YCW 4528</b>
BP 161 P, BP 121 S, BP 150, BP 310 P	E2	1x100	<b>YCW 5128</b>
BP 211 D, BP 221 S	E2	1x200	<b>YCW 5228</b>
BP 301 S	E2	1x200+ 1x100	<b>YCW 5228+ YCW 5128</b>
BP 410 S, BP 310 S, BP 410	F1	1x200	<b>YCW 5238</b>
BP 610	F2	1x500	<b>YCW 5548</b>
BP 3100 P, BP 1200, BP 2100 S	F1	1x1,000	<b>YCW 6138</b>
BP 4100 S			
BP 3100 S, BP 4100, BP 2100	F1	1x2,000	<b>YCW 6238</b>
BP 8100, BP 6100	F1	1x5,000	<b>YCW 6538</b>
BP 16000 S, BP 12000 S, BP 34000 P, BP 34	F1	1x10,000	<b>YCW 7138</b>

### **"SartoWedge" data transfer software program**

**YSW 01**

enables you to have data, recorded by your balance, input directly into any application program you are running on your PC (e.g., Excel). Memory-resident software (5 KB) for all IBM-compatible computers and balances that are equipped with a serial interface. This applications kit includes the following software and equipment:

- 3½" or 5¼" program diskette
- interface cable
- manual

### **"BalanceReader" software**

**YAK 10 PC-0002**

for collecting data that are transmitted by your Sartorius balance to a commercially available personal computer. These data are read into spreadsheets and stored. The stored spreadsheets can be further processed using commercially available standard software (Excel, Lotus 1-2-3, etc.). This applications kit includes the following software and equipment:

- 3½" and 5¼" program diskettes
- program description
- interface cable
- adapter (25-pin to 9-pin)

Product	Order No.
<b>Industrial-grade power supply, ING1,</b> IP 65-protected in accordance with DIN VDE 0470/IEC 529 – for 230 V – for 120 V	<b>69 71476</b> <b>69 71480</b>
<b>Density determination set</b> – for the BP 211 D, BP 301 S, BP 221 S, BP 161 P and BP 121 S – for the BP 211 D, BP 301 S, BP 221 S, BP 161 P and BP 121 S (-OCE)	<b>YDK 01</b> <b>YDK 01-0D</b>
<b>Antistatic pan</b> – for BP 211 D, BP 301 S, BP 221 S, BP 161 P, BP 121 S and BP 61 S	<b>YWP 01 BA</b>
<b>Analytical draft shield chamber</b> for the BP 410 S, BP 310 P, BP 310 S, BP 150 and BP 110(-OCE)	<b>YDS 01 BP</b>
<b>Universal remote control switch</b> with menu code definable Print, Tare, <input type="checkbox"/> F or <input type="checkbox"/> CF key function	<b>YFS 01</b>
<b>Foot switch with T-connector</b>	<b>YHS 01</b>
<b>Hand switch with T-connector</b>	<b>YTC 01</b>
<b>T-connector</b>	<b>YWT 01</b>
<b>Balance table</b>	<b>6708-62</b>
<b>Forceps</b>	<b>6708-02</b>
<b>Brush</b>	<b>69 60BP01</b>
<b>Dust cover</b> – for the BP 410 S, BP 310 S, BP 310 P, BP 150, BP 610 (-OCE), BP 410, BP 110-OCE – for the BP 4100 S, BP 3100 S, BP 3100 P, BP 2100 S, BP 1200 (-OCE), BP 2100-OCE – for the BP 8100, BP 6100, BP 2100, BP 8, (-OCE), BP 4100	<b>69 60BP02</b> <b>69 60BP03</b>

# Declarations of Conformity

## The **CE** Mark on Sartorius Equipment

In 1985, the Council of the European Community approved a resolution concerning a new approach to the technical harmonization and standardization of national regulations.

The organization for monitoring compliance with the directives and standards concerning the **CE** marking is governed in the individual EU Member States through the implementation of the EC Directives adopted by the respective national laws. As of December 1993, the scope of validity for all EC Directives has been extended to the Member States of the European Union and the Signatories of the Agreement on the European Economic Area.

Sartorius complies with the EC Directives and European Standards in order to supply its customers with weighing instruments that feature the latest advanced technology and provide many years of trouble-free service.

## **CE** Marking

The **CE** marking affixed to the equipment indicates that the equipment meets the requirements of the following Directive(s):

### **Council Directive 89/336/EEC "Electromagnetic compatibility (EMC)"**

This Directive regulates the use of equipment that can cause electromagnetic interference or whose functioning can be influenced by such interference.

Applicable European Standards:

Limitation of emissions	EN 50081-1	Residential, commercial and light industry
	EN 50081-2	Industrial environment
Defined immunity to interference	EN 50082-1	Residential, commercial and light industry
	EN 50082-2	Industrial environment

### **Important Note:**

The operator shall be responsible for any modifications to Sartorius equipment and for any connections of cables or equipment not supplied by Sartorius and must check and, if necessary, correct these modifications and connections.

On request, Sartorius will provide information on the minimum operating specifications (in accordance with the Standards listed on the previous page for defined immunity to interference).

### **Council Directive 73/23/EEC “Electrical equipment designed for use within certain voltage limits”**

Applicable European Standards:

**EN 60950** Safety of information technology equipment including electrical business equipment

**EN 61010** Safety requirements for electrical equipment for measurement, control and laboratory use  
Part 1: General requirements

If you use electrical equipment in installations and under ambient conditions requiring higher safety standards, you must comply with the provisions as specified in the applicable regulations for installation in your country.

### **Weighing Instruments for Use in Legal Metrology: 90/384/EEC “Non-automatic weighing instruments”**

This directive regulates the determination of mass in legal metrology

For the respective Declaration of Type Conformity for weighing instruments that have been verified by Sartorius for use as legal measuring instruments and that have an EC Type-Approval Certificate, see page 87.



This Directive also regulates the performance of the EC verification by the manufacturer, provided that an EC Type-Approval Certificate has been issued and the manufacturer has been accredited by an officer of a Notified Body registered at the Commission of the European Community for performing such verification.

The legal basis allowing Sartorius to perform EC verification is constituted by the EC Council Directive No. 90/384/EEC on non-automatic weighing instruments that has been in effect since January 1, 1993, in the Internal Market as well as by the Certificate of Accreditation of the Sartorius AG Quality Management System issued by the Metrology Department of the Regional Administration Office of Lower Saxony, Germany ("Niedersächsisches Landesverwaltungsamt – Eichwesen") on February 15, 1993

For information on the **CE** marking on Sartorius equipment and legal regulations currently applicable in your country, and to obtain the names of the persons to contact, please ask your local Sartorius office, dealer or service center.

# DECLARATION OF TYPE CONFORMITY

## to Directive No. 90/384/EEC

This declaration is valid for non-automatic electromechanical weighing instruments for use in legal metrology. These weighing instruments accepted for legal metrological verification have an EC Type-Approval Certificate. The model(s) concerned is(are) listed below along with the respective type, accuracy class, and number of the EC Type-Approval Certificate:

Model	Type	Accuracy Class	EC Type-Approval Certificate No.
BP...-OCE	BC BC 100	I	D95-09-011
BP...-OCE	KA BC 100	I	D95-09-011
BP...-OCE	MB BC 100	I	D95-09-011
BP...-OCE	BA BC 200	II	D95-09-011
BP...-OCE	BD BC 200	II	D95-09-011

SARTORIUS AG declares that its weighing instrument types comply with the requirements of the Council Directive on non-automatic weighing instruments, no. 90/384/EEC of 20 June 1990; the associated European Standard "Metrological aspects of non-automatic weighing instruments," No. EN 45501; the amended, currently valid versions of the national laws and decrees concerning legal metrology and verification in the Member States of the European Union, the EU, and the Signatories of the Agreement on the European Economic Area, which have adopted this Council Directive into their national laws; and with the requirements stipulated on the Type-Approval Certificate for verification. This Declaration of Type Conformity is valid only if the ID label on the weighing instrument has the CE mark of conformity and the green metrology sticker with the stamped letter "M" (the two-digit number in large print stands for the year in which the mark has been affixed):

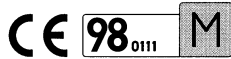

If these marks are not on the ID label, this Declaration of Type Conformity is not valid. Validity can be obtained, for example, by submitting the weighing instrument for final action to be taken by an authorized representative of SARTORIUS AG. The period of validity of this Declaration of Type Conformity shall expire upon any tampering with, repair or modification of this weighing instrument or, in some Member States, on the date of expiration.

The operator of this weighing instrument shall be responsible for obtaining an authorized renewal of the verification, such as subsequent or periodic verification, of the weighing instrument for use as a legal measuring instrument.

Signed in Goettingen on this day of November 13, 1998

**SARTORIUS AG**  
37070 Goettingen  
Germany

*[Signature]*  
Head of the Weighing Division  
(Warter)

*[Signature]*  
Head of Technical Operations  
(Dr. Maaz)

OAW-113-2/02.96  
P103EQ01

## **“EC Verification” – a Service Offered by Sartorius**

Our service technicians authorized to perform the verification\* of your weighing instruments that are acceptable for legal metrological verification can inspect and verify the metrological specifications at the place of installation within the Member States of the European Union and the Signatories of the European Economic Area.

### **“New Installation” Service**

Initial verification is covered in our “New Installation” service package. In addition to initial verification, this package provides you with a series of important services which will guarantee you optimal results in working with your weighing instrument:

- Installation
- Startup
- Inspection
- Training
- Initial verification

### **Subsequent Verifications within the European Countries**

The validity of the verification will become void in accordance with the national regulations of the country in which the weighing instrument is used. For information on verification and legal regulations currently applicable in your country, and to obtain the names of persons to contact, please ask your local Sartorius office, dealer or service center.

\* in accordance with the accreditation certificate issued to Sartorius AG

### **Subsequent Verifications within the European Countries**

The validity of the verification will become void in accordance with the national regulations of the country in which the weighing instrument is used. For information on verification and legal regulations currently applicable in your country, and to obtain the names of the persons to contact, please contact your local Sartorius office, dealer or service center as indicated on the following page.

## Sartorius AG

✉ 37070 Goettingen, Germany

🏠 Weender Landstrasse 94-108, 37075 Goettingen, Germany

☎ (+49/551) 308-0, 📠 (+49/551) 308-289

Internet: <http://www.sartorius.com>

Copyright by Sartorius AG, Goettingen, Germany.  
All rights reserved. No part of this publication  
may be reprinted or translated in any form or by any means  
without the prior written permission of Sartorius AG.

The status of the information, specifications and  
illustrations in this manual is indicated by the date  
given below. Sartorius AG reserves the right to  
make changes to the technology, features,  
specifications and design of the equipment  
without notice.

Status: Mai 2000, Sartorius AG, Goettingen, Germany